

 **IO-Link**



Pyrometer
CellaTemp
PK/PKF/PKL xx BF

Ident no.: 1127067 09/2024

Content

1	General	5
1.1	Information about this manual	5
1.2	Explanation of symbols	5
1.3	Liability and Warranty	5
1.4	Copyright	6
2	Safety	6
2.1	Intended use	6
2.2	User's responsibility	6
2.3	Safety requirements	6
2.4	Laser Radiation Hazard	6
3	Shipping, packaging and disposal	8
3.1	Inspection after shipping	8
3.2	Inspection after shipping	8
3.3	Disposal of the old devices	8
4	Theory of Non-Contact Temperature Measurements	9
4.1	Advantages of Non-Contact Temperature Measurement	9
4.2	Measurements at Black Bodies (Cavity Radiators)	9
4.3	Measurements of Real Radiators	10
4.4	Measurements errors	10
5	Ways to determine emissivity	11
6	Function	11
7	Installation	11
7.1	Mounting	11
7.2	Alignment	12
7.3	Focusing the fiber optic head	13
8	Electrical connection	14
9	Setup	15
9.1	Emissivity	15
9.2	Transmission factor	15

10	Shielding and Grounding	16
10.1	Equipotential bonding.....	16
11	Operating controls and display	17
11.1	Processing of measuring signals.....	18
11.2	Analogue output	18
11.3	Switching threshold OUT 1.....	19
11.4	Output signal OUT 1.....	19
11.5	Switch on delay OUT 1.....	19
11.6	Switch off delay OUT 1.....	19
11.7	Hysteresis function	20
11.8	Window function	21
11.9	Switching output OUT 2.....	22
11.10	Damping function	22
11.11	Peak hold function.....	23
11.12	Temperature correction for process-specific influences	24
12	Smart functions.....	25
12.1	Vitality indicator	25
12.2	Operating hours counter.....	25
12.3	Parameterisation of the service request message	25
12.4	Indoor temperature histogram (IO-Link only)	26
13	IO-Link	26
14	Menu.....	27
14.1	Analogue output Ao	27
14.2	Switching output OUT 1.....	28
14.3	Switching output OUT 2.....	29
14.4	Spectral channel.....	30
14.5	Advanced Features	31
15	Menu explanation	32
15.1	Analogue output	32
15.2	Digital output (d1)	33
15.3	Digital output (d2)	34
15.4	Spectral channel (S).....	35
15.5	Advanced Features (EF)	36

16	Operating parameters.....	37
16.1	Setting parameters – general information	37
17	Error indications.....	39
18	Service functions	39
18.1	Reset all parameters to factory settings	39
18.2	Simulate a desired temperature	40
19	Diagnostics	41
19.1	Diagnostic messages (pyrometer display)	41
19.2	Diagnostic messages IO-Link.....	41
19.3	Service reset	42
20	Maintenance	43
20.1	Cleaning the pyrometer lens	43
20.2	Replacing the protective screen.....	43
21	General technical data.....	44
22	Device-specific technical data	45
23	Accessories	60
24	Default settings.....	60
25	Copyright	60

1 General

1.1 Information about this manual

The Operating Manual shall enable the user to properly install the pyrometer and the required accessories.

Before starting installation, be sure to read and understand this entire manual, in particular the chapter on safety! The instructions contained in this manual, especially those concerning safety, as well as site specific regulations governing UV radiation must be complied with at all times. It is imperative to comply with the safety instructions and the accident protection regulations valid for the area of application.

1.2 Explanation of symbols

Important safety-related references in this manual are marked with a symbol.

ATTENTION

This symbol points out guidelines. If you do not observe them, the device might be damaged, malfunctioning or even fail to operate.

CAUTION

This symbol points out hints and information which should be heeded for efficient and trouble-free operation

- ▶ Action
This symbol instructs the operator to take action.
- > Reaction, Result
This symbol indicates the result of the action taken.

1.3 Liability and Warranty

All information compiled in this manual is in accordance with applicable regulations. The statements made are based on state-of-the-art technology and reflect our extensive knowledge and many years of experience.

-  Always carefully read this Operating Manual before beginning any work on or with the instrument, especially prior to installation and initial setup! The Manufacturer shall not be held liable for any damages or malfunctions arising from a disregard of the warnings and instructions contained herein.

1.4 Copyright

This Operating Manual should be treated as confidential. It is solely intended for use by persons involved with the instrument. This manual may not be made available to a third party without prior Manufacturer's consent. Please contact the Manufacturer if the need should arise.

2 Safety

This chapter outlines all important safety aspects to be considered for optimum employee protection and to ensure safe and reliable operations.

2.1 Intended use

The pyrometer is solely intended for use as described in this manual. Operational safety can only be ensured when the instrument is used for its intended purpose.



The use of the pyrometer for any other purpose beyond what is specified in this manual is prohibited. Using the instrument in any other manner will be considered as improper.

The manufacturer is only liable for damage that occurs during correct use. The prerequisite for any liability, however, is that the cause of the damage is due to a defective product and the defect in the product was caused by the manufacturer.

2.2 User's responsibility

The pyrometer may only be used when it is in perfect working condition.

2.3 Safety requirements

The instrument operates at low voltage (18 – 30 V DC). The power supply unit must conform to directive EN50178, SELV, PELV.

2.4 Laser Radiation Hazard

Laser Radiation Hazard: Laser radiation can be harmful to eye!

The laser pointer operates with a class 2 red light laser. Direct prolonged viewing of a laser beam can injure the retina. Therefore, the following safety precautions must be strictly observed, otherwise the laser may not be operated!

- Only use the laser to align and focus the pyrometer. Deactivate the laser immediately afterwards.
- Never look directly into the laser beam path.
- Do not leave the instrument unattended when the laser is activated.
- Do not point the laser beam at any person.
- During pyrometer installation and alignment, make sure to avoid the possibility of laser light reflections caused by reflective surfaces.
- All currently valid laser safety standards must be observed.

EN

Laser Power

The laser operates at a wavelength of 630 - 680 nm (visible red light). The emitted power of the laser beam at the lens opening is max. 1.3 mW. Under normal operating conditions, the emitted radiation does not present a danger to human skin. This laser product is classified according to laser class 2, IEC 60825-1.

Laser Warning Label

The black and yellow laser warning label is affixed on the laser pointer.



3 Shipping, packaging and disposal

3.1 Inspection after shipping

Unpack and inspect the entire shipment immediately upon receipt to make sure it is complete and undamaged.

If the container/package shows visible signs of damage, please refuse the shipment. If this is not possible, accept the shipment on the condition that the freight carrier's delivery record is noted with the extent of the damage in order to file a claim.

Should you discover a concealed loss or damage, report it to the shipper or freight carrier immediately. If the period for filing claims has expired, you will no longer be able to make any claims for compensation of damage or loss.

3.2 Packaging

The packages used are made of carefully selected, environmentally compatible materials and are thus recyclable.

The packaging must be kept for despatch or disposed of in an environmentally friendly manner.

3.3 Disposal of the old devices



Old electrical and electronic devices frequently still contain valuable materials.

These devices can be returned for disposal to the manufacturer or they must be disposed properly by the user.

For the improper disposal of the device by the user, the company KELLER HCW is not responsible.

4 Theory of Non-Contact Temperature Measurements

All materials radiate thermal energy in all states of aggregation above absolute zero. This radiation is mainly caused by atomic or molecular oscillations.

This temperature radiation is only a limited sector within the total electromagnetic radiation spectrum. It extends from the visible range starting at wavelengths of approx. 0.5 μm to the infrared range with wavelengths of more than 40 μm .

Radiation pyrometers detect infrared radiation for non-contact temperature measurement.

4.1 Advantages of Non-Contact Temperature Measurement

- Non-contact temperature detection means cost-effective temperature measurement because this technique only requires a single investment in an instrument without any follow-up costs for consumables such as thermocouples.
- This method enables temperature detection of moving objects - quick temperature measurements within milliseconds - for example at automatic welding processes.
- Small objects with medium and high temperatures can also be easily and accurately measured.
- When measuring materials with low specific heat, a non-contact method does not induce heat loss which would distort the temperature reading (as is the case with contact temperature probes). Non-contact temperature detection is ideal with corrosive molten materials for which the use of thermocouples is hardly feasible.
- Last but not least it is also possible to measure the temperature of voltage-carrying objects.

4.2 Measurements at Black Bodies (Cavity Radiators)

A black body or a black radiator is used to calibrate radiation pyrometers. This black body is designed in a way that its radiation does not depend on material characteristics, but only on its temperature. A black body emits at any wavelength the maximum energy possible for the specific temperature. Real bodies do not have this ability. In other words, a black body completely absorbs the radiation without reflection or transmission losses. The spectral emissivity coefficient $\epsilon(\lambda)$ of

a black body is equal to 1 or 100 %. The emissivity coefficient indicates the ratio of radiation of a real body (target) to the radiation of an ideal black body.

$$\varepsilon(\lambda) = \frac{M}{M_S}$$

$\varepsilon(\lambda)$: Emissivity coefficient of the object's surface (targeted spot) at wavelength λ

M: radiant energy actually emitted by a real object

M_S : radiant energy emitted by a black body (perfect radiator)

Most burning, annealing and hardening furnaces emit a radiation of nearly ,1' which corresponds to the conditions of a black body if the aperture through which the measurement is made is relatively small.

4.3 Measurements of Real Radiators

Real radiation sources are characterized by the relation of the emitted radiation to the radiation of a black body with the same temperature. Measurements outside a furnace - which applies to all other self-contained targets - always show a reading which is too low. Considerable errors can occur at targets with reflecting, polished or bright surfaces, e.g. molten steel and metal without oxide layer and ceramic materials. Exact results can only be obtained when the emissivity coefficient is correctly adjusted on the pyrometer.

The spectral emissivity coefficient of a body does not represent an exact material constant, but is also largely dependent on the surface properties (→ Ways to determine emissivity).

4.4 Measurements errors

The cause of measurement errors in the use of pyrometers is often an incorrectly determined or wrong emissivity.

Another source of error is the reflected „background radiation“.

If the measurement object has a low emissivity and there are hotter objects in the surrounding area, measurement results can be affected. These objects then have to be shaded. This effect is particularly to be observed in the measurement of a colder object within a hot oven.

5 Ways to determine emissivity

Data on the emissivity of various substances can be found in the literature. However, this information should be treated with caution. It is important to know for which temperature and which wavelength the emissivity value is applicable. Furthermore, the stated emissivity values were obtained under ideal conditions. In actual practice, the total emissivity of the target object will vary, depending on the amount of extraneous radiation transmitted through the object from the background or reflected onto the object from the foreground.

The emissivity can be determined using one of the following methods:

Contact measurements

Measure the temperature with a contact thermocouple and measure the surface temperature with a pyrometer. Adjust the emissivity coefficient on the pyrometer until both devices show the same temperature. When measuring with the thermocouple, make sure to have good thermal contact and low heat dissipation.

Using a reference emissivity coefficient

Apply matte black colour to a part of the surface to be measured. This part has an emissivity of 94 %. At first, measure the temperature of the coloured part. Then make a comparative measurement right next to the coloured part and adjust the emissivity on the pyrometer until it displays the previous measurement reading again.

6 Function

The pyrometer detects the infrared radiation emitted by objects without contact and converts this into an electrical switching signal and an analogue output signal.

7 Installation

7.1 Mounting

The pyrometer should be mounted where it is not unnecessarily exposed to smoke, heat or water vapour.

Contamination of the lens can lead to measurement errors. Therefore, always ensure that the lens is clean.

The pyrometer's field of vision must remain unobstructed. Any interference from objects must be avoided.

⚠ ATTENTION

If the ambient temperature is $> 65\text{ }^{\circ}\text{C}$, the pyrometer must be cooled or protected against radiation by a shielding plate.

7.2 Alignment

Align the pyrometer with the object to be measured. If possible, the pyrometer should be installed at a 90° angle to the object to be measured. The angle should not be less than 45° from the vertical. With a spectral pyrometer, the object to be measured must completely fill the measuring field.

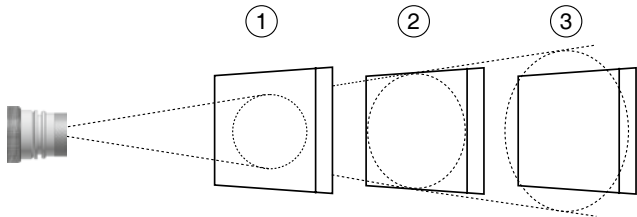

1	Optimal - object larger than the measuring spot
2	Critical - object the same size as the measuring spot
3	Unfavourable - measuring spot larger than the object

7.3 Focusing the fiber optic head

If the pyrometer has a fiber optic, it could be necessary to focus the measuring head additionally.

For that, the laser pointer is to be connected to the fiber optic and to be activated by using a button! The safety instructions in chapter 2.4 must be observed!

**EN**

For focal adjustment loosen the shown socket screw (hexagon socket screw DIN 916) with a wrench (DIN 911) and shift the internal body of the tube towards the lens tube. Due to the O-ring sealing between the internal body of the tube and the lens tube the focal adjustment must be carried out very slowly so that the air pressure in the space between lens and internal body of the tube can be equalised.

Focus the sensing head until the spot light is shown as a sharp round laser spot in the target area. In bright daylight or in an excessively lit environment it is recommendable to dim the area around the target.

8 Electrical connection

⚠ ATTENTION

- The pyrometer may only be installed by a skilled, qualified electrician. Do not connect the instrument while the voltage supply source is turned on. Please observe international safety regulations at all times.
- The pyrometer is supplied with low voltage 24 V DC. The power supply must comply with the regulations for safety extra-low voltage EN 501178, SELV, PELV.

- ▶ Switch to neutral and verify absence of voltage
- ▶ Connect the instrument according to the following schematic:

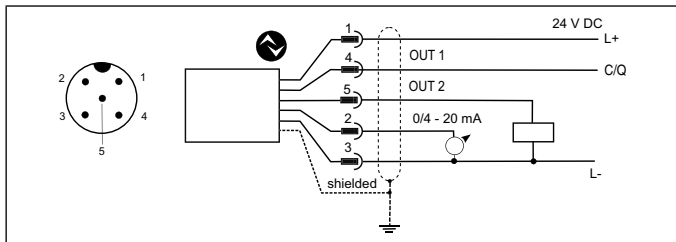

Pin 1	BN (brown)	L+ (Power supply 24V DC)
Pin 4	BK (black)	Open Collector switching output; $I_{\max} = 150 \text{ mA}$ or IO-Link OUT 1
Pin 5	GY (grey)	Open Collector switching output; $I_{\max} = 150 \text{ mA}$ OUT2
Pin 2	WH (white)	Analogue output; 0/4 ... 20mA
Pin 3	BU (blue)	L- (Shield)



Use a shielded cable. The shield of the cable must be connected to the sensor housing.



Use a flyback diode when switching inductive loads.

9 Setup

9.1 Emissivity

The pyrometer uses the intensity of infrared radiation for non-contact temperature measurements. It is necessary to configure the pyrometer to the respective emissivity coefficient of the measuring object to obtain exact measuring results (→ Emissivity coefficient tables).

An incorrectly set emissivity coefficient leads to wrong temperature readings. Set the emissivity coefficient after connecting the supply voltage or resetting the parameters to factory settings.

- ▶ Press [▲ or ▼]
- > the value of the selected emissivity is displayed, for example [1000]
- ▶ Press [▲ or ▼] until the desired emissivity is shown
- ▶ Press [Enter] or wait for 3 seconds

The current temperature value is displayed. The pyrometer now works with this configured emissivity until it is changed again.



To compensate for environmental influences, it may be useful to set an emissivity > 100 %. A setting of up to 110 % is therefore possible.

! ATTENTION

An incorrectly set emissivity coefficient leads to wrong temperature readings.

9.2 Transmission factor

In addition to the aforementioned emissivity correction, the transmission properties of protective panes/lenses can be taken into account on the pyrometer. The transmission value printed on the pane/lens or taken from the specifications must be set as a percentage value in the pyrometer. Without protective discs/lenses, set 100.0 here (default value).

Transmission factor [5] → [5t RU] = 10 – 100 %

10 Shielding and Grounding

10.1 Equipotential bonding

The pyrometer housing is connected to the shielding via the cable connector!

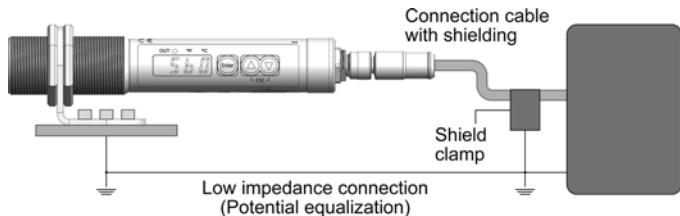

Differences in ground potentials might cause an equalising current to flow between devices through a cable shielded at both ends. In this case, be sure to install an additional equipotential bonding line.

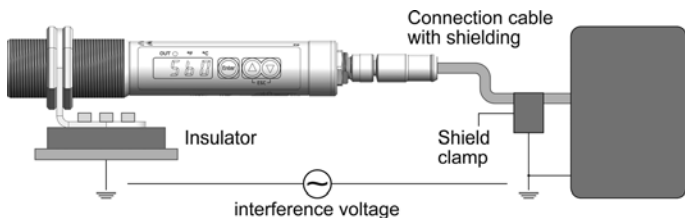

To avoid an equalising current, the pyrometer can be mounted electrically insulated. The shielding must be connected to the plant's earthing system.



If the pyrometer is installed without an insulator and without potential equalisation, the interference voltage may not exceed 32V.

11 Operating controls and display

The pyrometer PK features a 4-digit display, 3 control keys and 3 LEDs. The instrument's display panel shows the measured temperature.

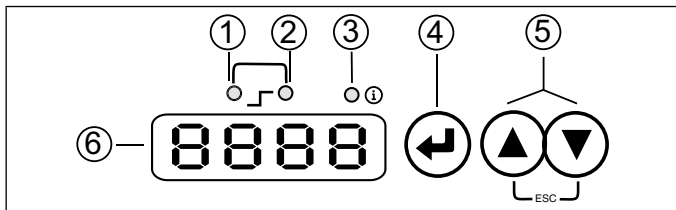

EN

1 to 3: Indicator-LEDs

LED 1 = Switching state of the switching output OUT1

LED 2 = Switching state of the switching output OUT2

LED 3 = Info/Diagnosis

4: Control key [Enter]

- Select parameter
- Reading out the set values
- Confirmation of the parameter values

5: Control key [^] and [v]

- Select parameter
- Activating the emissivity quick adjustment
- Changing parameter values

6: Alphanumeric display, 4-digit

- Indicates temperature value
- Indicates parameters and configuration
- Indicates overload at switching output

11.1 Processing of measuring signals

The pyrometer disposes of an IO-Link interface.

The generated three output signals correspond to the parameterization:

- Out 1: Switching output/ IO-Link
 - Switch signal: threshold value temperature / status signal
- Out 2: Switching output
 - Switch signal: threshold for temperature / status signal
- Analogue output: 0/4 -20 mA
 - Analogue output for temperature

11.2 Analogue output

The pyrometer converts the measuring signal into a temperature proportional analogue signal of 0/4 – 20 mA. The maximum load is 500 Ohm.

[R0F] Changeover 0 -20 mA or 4 -20 mA

[R0SP] defines at which measured value the output signal is 0/4 mA.

[R0EP] defines at which measured value the output signal is 20 mA.

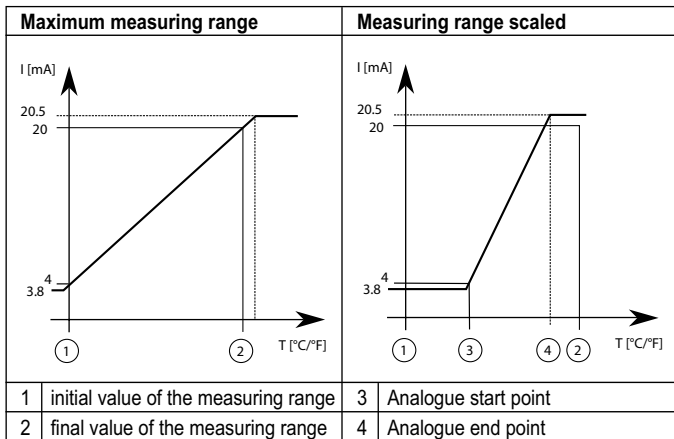

11.3 Switching threshold OUT 1

OUT1 changes its switching status when the configured upper or lower thresholds $[d\ I.S.P.]$ and $[d\ I.r.P.]$ are exceeded. Source $d\ I.S.$ specifies the signal that is output at OUT1.

- Spectral channel $[d\ I.] \rightarrow [d\ I.S.] = L\ I$

First, the switching point $[d\ I.S.P.]$ is set in °C and °F and then the reset point $[d\ I.r.P.]$. When changing $[d\ I.S.P.]$, the $[d\ I.r.P.]$ also changes so that the difference remains the same. If the $[d\ I.S.P.]$ is reduced to such an extent that the distance can no longer be maintained (as the $[d\ I.r.P.]$ would otherwise move below its minimum), the $[d\ I.r.P.]$ is increased to its minimum. If $[d\ I.S.P.]$ is subsequently increased again, $[d\ I.r.P.]$ is also increased again immediately. The minimum distance between $[d\ I.S.P.]$ and $[d\ I.r.P.]$ is 1 K.

11.4 Output signal OUT 1

The following output functions can be selected:

- Normally open contact $[d\ I.] \rightarrow [d\ I.F.n] = h.n.o$ hysteresis function, normally open or rather $F.n.o$ window function, normally open
- Normally closed contact $[d\ I.] \rightarrow [d\ I.F.n] = h.n.c$ hysteresis function, normally closed or rather $F.n.c$ windows function, normally closed

11.5 Switch on delay OUT 1

Once the sensor has detected a temperature which exceeds the switching threshold $[d\ I.S.P.]$ the time delay $[d\ I.d.S.]$ starts running. When this delay period has elapsed, the output OUT 1 activates switching. This status is sustained until the lower threshold $[d\ I.r.P.]$ is violated. If this occurs before the time delay has elapsed, the delay will reset. This function can be used, for example, to suppress spurious impulse signals at the output.

- Switching on delay: $[d\ I.] \rightarrow [d\ I.d.S.] = 0...10\ \text{sec.}$

11.6 Switch off delay OUT 1

To make sure the output is correctly identified, e.g. by downstream control system, the output can be lengthened.

- Switch off delay: $[d\ I.] \rightarrow [d\ I.d.r.] = 0...10\ \text{sec.}$

11.7 Hysteresis function

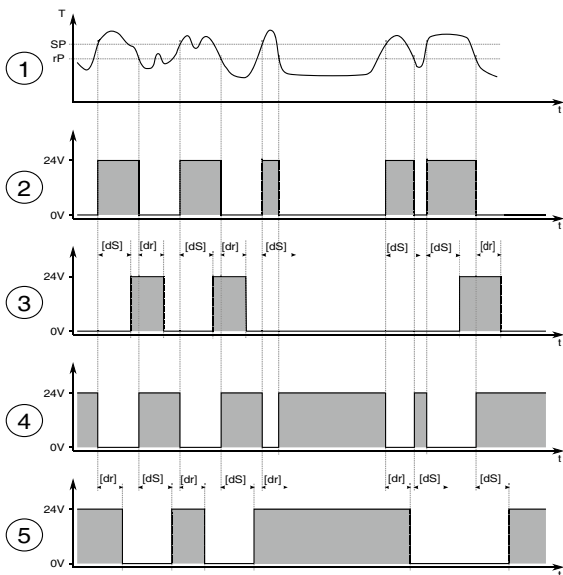

T = temperature rP = reset point
 t = time dS = switch on delay
 SP = set point dR = switch off delay

1	Temperature
2	Switch signal h _{no}
3	Switch signal h _{no} with switch on delay and switch off delay
4	Switch signal h _{nc}
5	Switch signal h _{nc} with switch on delay and switch off delay

11.8 Window function

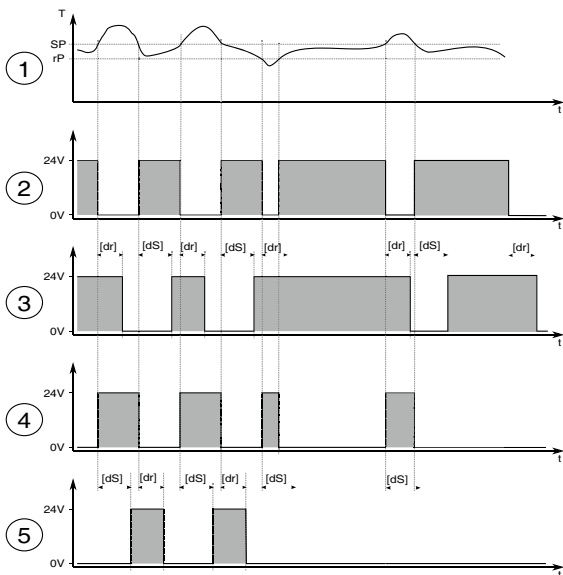

EN

T = temperature rP = lower limit value
 t = time dS = switch on delay
 SP = upper limit value dr = switch off delay

1	Temperature
2	Switch signal F_{no}
3	Switch signal F_{no} with switch on delay and switch off delay
4	Switch signal F_{nc}
5	Switch signal F_{nc} with switch on delay and switch off delay



The switching thresholds of the window function have a hysteresis of ± 0.05 K.

11.9 Switching output OUT 2

OUT2 changes its switching state according to the adjusted function. The functions and parameters are the same as OUT 1.

11.10 Damping function

When the target object's temperature is erratic, the damping function smoothens these temperature fluctuations in order to stabilize the measuring signal. The greater the time constant $[S] \rightarrow [SF, L]$, the lower the effect of fluctuations on the yielded temperature reading.

A_o

[mA]

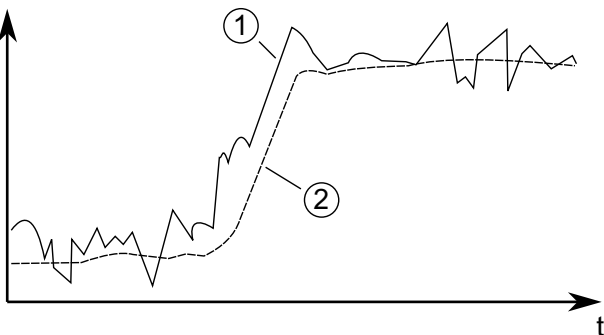

1	Output signal without smoothing function
2	Output signal with smoothing function

11.11 Peak hold function

It might often be desirable to determine the peak temperature during a defined time period, for example when the objects to be measured move past the pyrometer, resulting in temperature readings which would appear to be cyclical. In this mode, the displayed temperature reading will not drop between targeted objects. The peak temperature reading will be held for a preset time period. To do this, set the maximum value memory [SNE N] to Peakhold [PHLD].

The hold time [S] → [SPHd] → [SPEt] can be set from 0.1 to 999.9 sec. The maximum temperatures sampled during the defined hold time will be saved. It make sense to choose a hold time which is approximate 1.5 time as long as cycle of the moving targets. This avoids temperature drops. Any changes are recognised at once.

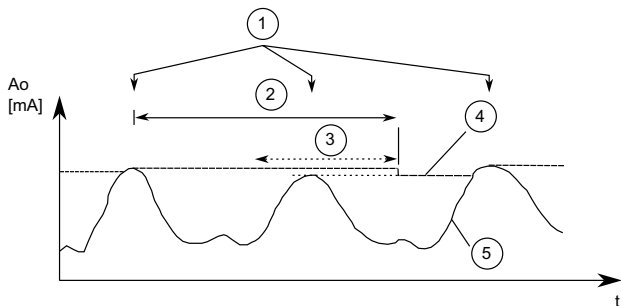

1	Measuring object in front of the pyrometer
2	Hold time
3	Second internal hold time
4	Measuring reading with peak hold function
5	Measuring reading without peak hold function

11.12 Temperature correction for process-specific influences

If required, the measured temperature can be corrected using a freely adjustable table. Between 1 and 5 grid points (X/Y pairs) can be entered, which are then linearly interpolated in the measured value processing (see illustration). For values smaller than the 1st interpolation point or larger than the last interpolation point, the first/last segment is extrapolated linearly internally. All grid points must be entered in ascending order.

Linearisation can be accessed via the menu using **S / S L I n**.

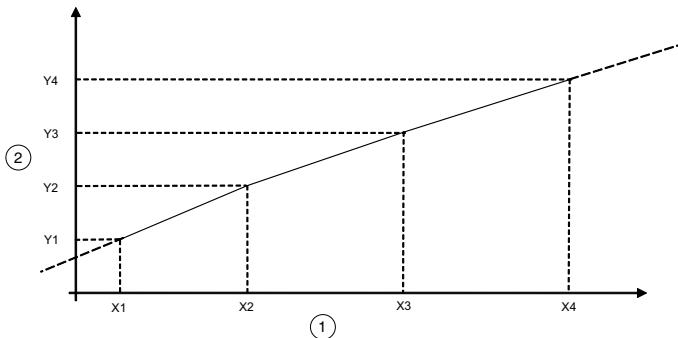

1	Input temperature
2	Initial temperature



The selection of only one grid point has the same effect as an offset.

12 Smart functions

Frequent changes in high ambient temperatures can affect electronic components and accelerate their aging processes.

Such aging influences the calibration of pyrometers.

The vitality indicator and the operating hours counter are available for monitoring and warning purposes.

12.1 Vitality indicator

The vitality indicator is calculated using the operating hours and the internal temperatures determined during operation. The pyrometer starts with a vitality indicator of 100% and drops to 0% during operation. In the worst case, i.e. in continuous operation and at a permanent ambient temperature of 65 °C, the threshold of 10 % is reached after two years. In comparison, if the pyrometer is operated at 25 °C, the threshold of 10 % is reached after 25 years.

12.2 Operating hours counter

The counter totals the operating hours of the pyrometer since the last service reset.

12.3 Parameterisation of the service request message

The service request message is not activated on delivery. The service request message appears when the vitality indicator falls below or exceeds the operating hours.

The threshold for the operating hours as well as for the vitality indicator can be set via the menu or via IO-Link.

Menu

To change the parameters, switch to the „E F “ -> Diagnostic messages „d, R6 “ submenu.

Parameter	Parameter
d, R6	uL, n Service limit value Vitality factor 0.0 ... 100.0
	hL, n Service limit value in operating hours x 1000

IO-Link

Index	Sub-index	Note	Value range	Gradient
8000	0	Service threshold Vitality indicator	0..1000 (0: OFF)	0.1
8001	0	Service limit value Operating hours	0..1000 (0: OFF)	1000

12.4 Indoor temperature histogram (IO-Link only)

The pyrometer has an internal temperature histogram. In this histogram, the internal temperatures of the pyrometer are stored in a range of -20 ... + 120 °C in 5 K steps.

The histogram can be read out via IO-Link.

Index	Sub-index	Note	Value range	Gradient
8030	0	Indoor temperature histogram Hours since service reset	0..2 ³²	1

Further information can be found in the IODD description.

13 IO-Link

The device has an IO-Link communication interface, which requires an IO-Link-capable module (IO-Link master) for operation. The IO-Link interface allows direct access to process and diagnostic data and offers the possibility to parameterize the device during operation. The IODDs required for configuring the IO-Link device as well as detailed information on process data set-up, diagnostic functions and parameter indexes are available in the download area at www.keller-its.com. A 3-wire cable port Class A (Type A) must be used for IO-Link operation.

14.2 Switching output OUT 1

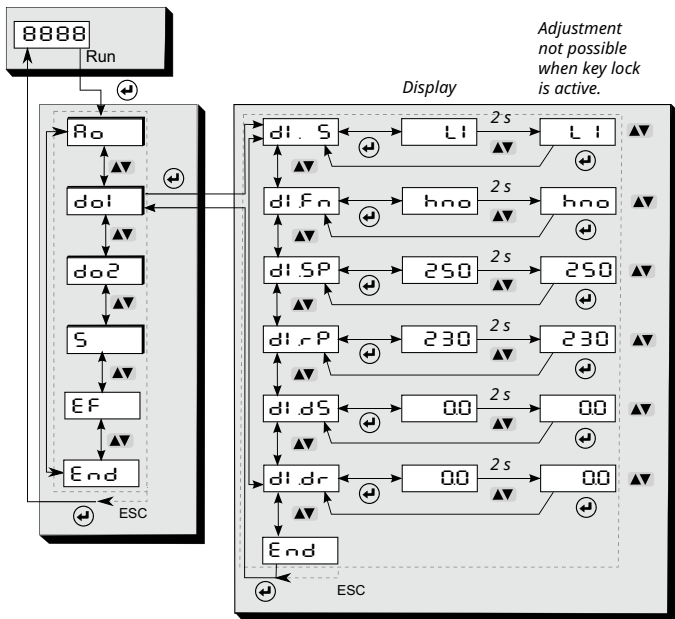

14.3 Switching output OUT 2

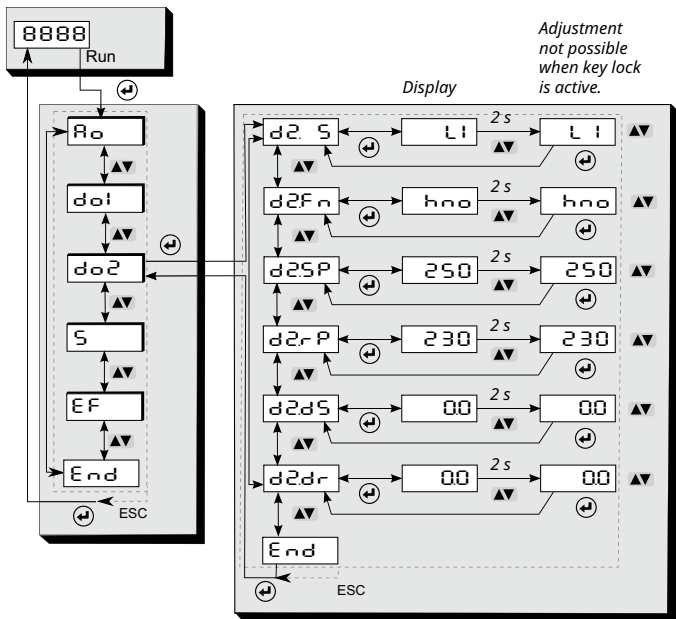

14.4 Spectral channel

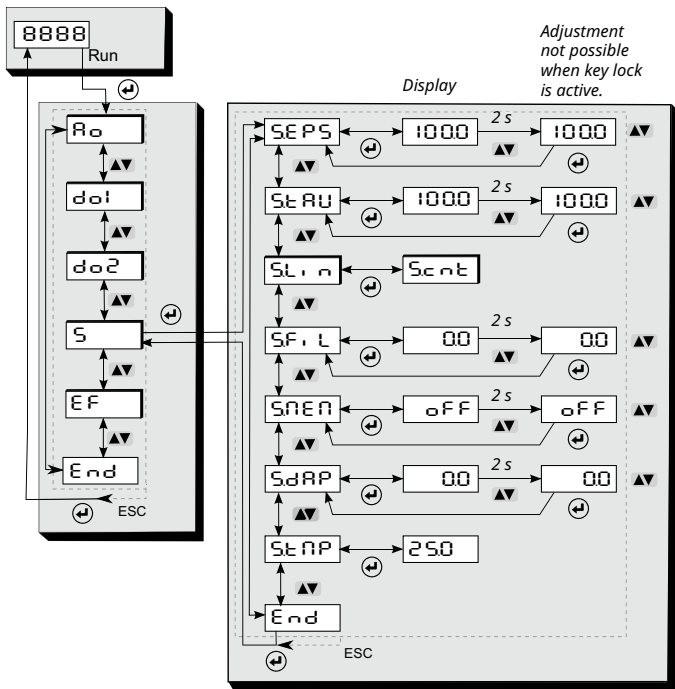

14.5 Advanced Features

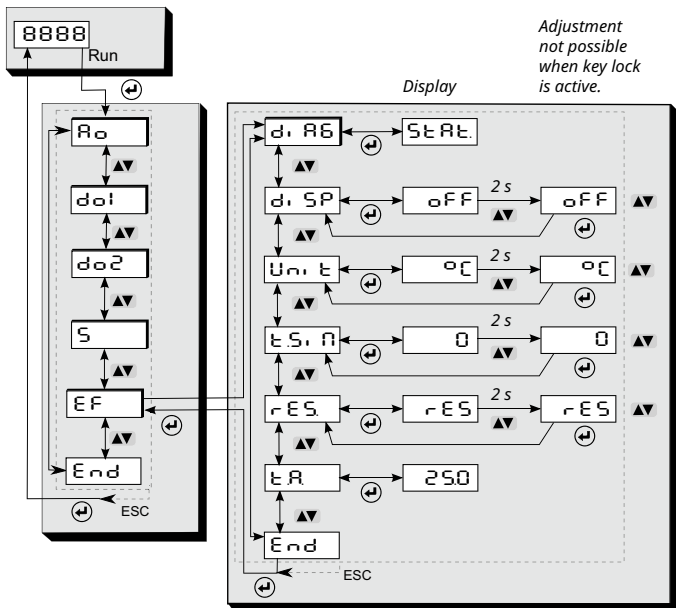

15 Menu explanation

15.1 Analogue output

Parameter	Function	Comments
R _α S	Source selection	L 1 Temperature Lambda 1
R _α F _n	Analogue output 0/4 – 20 mA	0 – 20 mA Analogue output 4 – 20 mA Analogue output
R _α SP	Analogue output Scaling start	Analogue start value for scaling
R _α EP	Analogue output Scaling end	Analogue end value for scaling
E _n d	End	

15.2 Digital output 1 (di)

Parameter	Function	Comments
di . S	OUT 1 Source	L 1 Temperature Lambda 1 E R Internal temperature
di F n	OUT 1 Switching function	h n o Hysteresis switching function (output active when the limit value is exceeded) h n c Hysteresis switching function (output inverted) F n o Window switching function F n c Window switching function (Exit active when leaving the area)
di . SP	OUT 1 upper threshold	Upper threshold which activates OUT 1
di . rP	OUT 1 lower threshold	Lower threshold which activates OUT 1
di . dS	Upper threshold delay	Value in sec (≤ 10 sec in steps of 0.1 sec)
di . dr	Lower threshold delay	Value in sec (≤ 10 sec in steps of 0.1 sec)
E n d	End	



The switching thresholds of the window function have a hysteresis of ± 0.05 K.

15.3 Digital output 2 (d2)

Parameter	Function	Comments
d2.5	OUT 2 Source	L1 Temperature Lambda 1 E1 Internal temperature
d2Fn	OUT 2 Switching function	hno Hysteresis switching function (output active when the limit value is exceeded) hnc Hysteresis switching function (output inverted) Fno Window switching function Fnc Window switching function (Exit active when leaving the area)
d2SP	OUT 2 upper threshold	Upper threshold which activates OUT 2
d2rP	OUT 2 lower threshold	Lower threshold which activates OUT 2
d2dS	Upper threshold delay	Value in sec (≤ 10 sec in steps of 0.1 sec)
d2dr	Lower threshold delay	Value in sec (≤ 10 sec in steps of 0.1 sec)
E nd	End	

15.4 Spectral channel (S)

Parameter	Function	Comments
SEPS	Emissivity	Correction of the radiation properties of the measured object (10...110%)
STRU	Transmission factor	Correction of the transmission factor 10 ... 100%
SLIN	Post-linearisation via user-configurable, freely definable table	
SCNT	Grid points	OFF Off 1-5 Number of sampling grid used
SHI*	Grid point x 1 ... 5	Input value grid point n
SHY*	Grid point y 1 ... 5	Output value grid point n
SFIL	Smoothing filter	Direct smoothing on the measured value 0 -999.9 s
SMEM	Extreme value memory	OFF Off PHLD Peakhold function
SPhd**		
SPhd, **	Holding time Peakhold	Time s (in 0.1 s steps)
SdRP	Smoothing filter	Smoothing of the output temperature 0 - 999.9 s
STNP	Temperature	Measuring temperature S
END	End	

* Only active with parameter SCNT 1-5

** Only active with extreme value memory PHLD

15.5 Advanced Features (EF)

Parameter	Function	Comments
dI R6	Diagnosis	S t R t Diagnostic messages with consecutive number* (if none are present, 4 dashes are shown in the display) u, t R Vitality indicator q, P u Undervoltage diagnosis q, P o Overvoltage diagnosis u L, n Service limit value Vitality factor 0 ... 100 h L, n Service limit value Operating hours 0 ... 1000 (Gradient 1000, 1 Δ 1000 h) E n d End
dI SP	Process value display	defines what is displayed in the process value display o n current temperature value o f f RUN is shown on the display
U n, t	Temperature unit	Temperature display in °F or °C
t S I n	Temperature simulation	a temperature can be simulated (affects the display and all outputs)
r E S	Factory settings	Reset to factory settings
t R	Internal temperature	Display of the current indoor temperature
E n d	End	

* see chapter 18

16 Operating parameters

When you reset/adjust the operating parameters the instrument remains in run mode. It continues to operate, using the current parameter settings, until you have finished configuring by pressing [Enter].

16.1 Setting parameters – general information

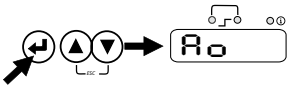
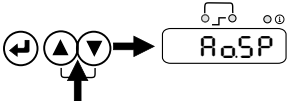
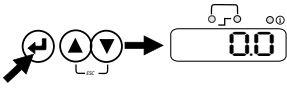
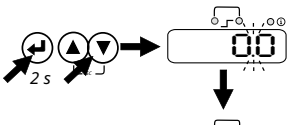
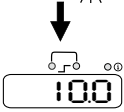
<p>1 Select parameter</p> <p>▶ Press [Enter] to access the main menu.</p>		EN
<p>2 Select output function</p> <p>Press key [▼] until the required output function or the Advanced Features is displayed.</p>		
<p>3 Show parameter value</p> <p>▶ Press [Enter]</p> <p>> Current parameter value is displayed. *</p>		
<p>* The pyrometer will display the parameter value for 30 sec. After that the display will once again indicate the measurement as a percentage.</p>		
<p>4 Change parameter value</p> <p>▶ Press [▲] or [▼] button for 2 sec.,</p> <p>> as long as the display flashes</p> <p>▶ Press [▲] or [▼] button to change the parameter</p>		
<p>Press and hold [▲] or [▼].</p> <p>> Accelerated throughput for numerical values</p>		

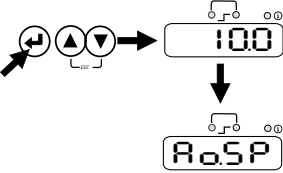
<p>5 Confirm parameter value</p> <ul style="list-style-type: none"> ▶ Press [Enter] > The display indicates the parameter. The new value has been saved and will take effect or > the parameter is discarded after 30 seconds 	
<p>Adjust additional parameters</p> <ul style="list-style-type: none"> ▶ Start again with step 2. 	
<p>Exit operating parameters layer</p> <ul style="list-style-type: none"> ▶ Wait 30 seconds <p>or</p> <ul style="list-style-type: none"> ▶ Press [▲] or [▼] to change to the parameter <code>End</code>. Then press [Enter] to change to the functional menu ▶ In the functional menu press [▲] or [▼] to change to the parameter <code>End</code>, then press [Enter]. 	



The instrument features a keylock. Activate/deactivate the keylock as follows:

- ▶ Press key [▲▼] simultaneously and hold them down for 10 sec.
- > The display shows Loc or uLoc for 1 second to signalize the change.



Durch gleichzeitiges Drücken der Tasten [▲▼] kann eine Ebene direkt verlassen werden oder die begonnene Parametereinstellung wird abgebrochen (ESC Funktion).



If [SLoc] is displayed, the sensor is permanently locked via software. This locking can only be removed with a parameter setting software.

17 Error indications

Overload output	The OUT 1/2 LED flashes with 4 Hz. The display shows "5 C " at 2 Hz.
Overtemperature	Display $\square \text{E}$ and the process value alternate at 0.5 Hz. The switching outputs are deactivated in the event of extreme overtemperature.
Supply voltage < 18 V and > 30 V	Diagnostics via menu
Temperature below lower threshold	The display shows UL .
Temperature above upper threshold	The display shows UL .

EN

18 Service functions

18.1 Reset all parameters to factory settings

▶	[r E S] Select extended functions [E F] in the menu
▶	Press [MODE]
>	RES is shown in the display
▶	Press the v key for 2 s
>	RES flashed for 2 s
▶	Release the key v key and press it again
>	---- is shown in the display
▶	Press [MODE] button
>	The current temperature is shown in the display



In order to carry out a correct measurement, the emissivity [E P S] must be reset after resetting to factory settings (→ 9 Setup).

18.2 Simulate a desired temperature

▶	[E . S . F] Select extended functions [E F]
▶	Press [MODE]
>	The display shows the previously set temperature
▶	Press the \wedge key for 2 s
>	Temperature flashes 3 times
▶	Use the keys \wedge \vee to set the desired temperature, release the key
>	The display alternately shows E . S . F and the temperature value
▶	Press [MODE] button
>	The display shows E . S . F and the simulation is completed
End simulation function	
▶	Press MODE button

19 Diagnostics

19.1 Diagnostic messages (pyrometer display)

If diagnostic messages occur, these are signalled with the Info LED and displayed under the STAT parameter (see table Extended function).

Message	Note	Display
Temperature simulation active	Measuring temperature is being simulated	SI R
Calibration data incomplete	Calibration not completed – end calibration	CAL.
Device hardware error	Replace pyrometer	FL E.
Maintenance required	Operating time has reached the set limit – maintenance recommended	SUC.
Device overtemperature	Maximum permissible internal temperature exceeded	OT.
Supply voltage too low (< 18 V)	Check power supply	UL O.
Supply voltage too high (> 30 V)	Check power supply	UHI .

EN

19.2 Diagnostic messages IO-Link

A detailed description of how to access the parameters can be found in the IODD description.

Service is signalled when the vitality indicator falls below the set threshold or when the set operating hours interval time is reached after the last service request.

“SVCE“ erfolgt beim Einschalten am Display. is signalled on the display when the device is switched on. The IO-Link status is set to “Maintenance-Required“.

Productive operation is still possible.

Parameter	Note
Vitality indicator	100 % after 0 % decreasing
QIPSU [0...100 %]*	Percentage of operating hours with undervoltage since the last service reset
QIPSO [0...100 %]*	Percentage of operating hours with overvoltage since the last service reset
Internal temperature histogram*	Internal temperature distribution since the last service reset
Internal temperature change indicator*	Temperature change indicator since the last service reset
Total operating hours	Operating hours since manufacture
Operating hours "Service"*	Operating hours since the last service reset
Vitality [0..100%] Signalling threshold	If the value falls below this, the service message Factory setting = 0% (deactivated) is displayed
Operating hours Service Interval time Threshold	If exceeded, the service message Factory setting = 0 h (deactivated) Can be set by the customer in thousands of hours
Service reset command	Resetting the service values marked with * (with customer calibration release)

19.3 Service reset

The service request is reset via the IO-Link system command.

Name	Index	Value	Comment
Standard command	2	165	Maintenance reset - Reset all internal diagnostic counters

20 Maintenance

20.1 Cleaning the pyrometer lens

A soiled lens leads to wrong display of the measured value.

- ▶ Check the lens regularly and clean it, if required.
 - Remove dust by blowing or with a soft brush.
 - Use clean, soft and lint-free cloths or those offered on the market for lens cleaning.
 - For heavier contamination, use washing-up liquid or liquid soap. Then carefully rinse with clear water. Hold the lens downwards.
 - Exert only little pressure on the lens during cleaning to avoid scratches.

20.2 Replacing the protective screen

To protect the pyrometer optics against contamination in harsh industrial environments, an additional protective screen is often used. A contamination of the protective screen also leads to a reduced indication of the measuring value.

- ▶ Check the protective screen regularly and clean it if necessary or replace it in case of damage.
 - Remove dust by blowing or with a soft brush.
 - Use clean, soft and lint-free cloths or those offered on the market for lens cleaning.
 - For heavier contamination, use washing-up liquid or liquid soap. Then carefully rinse with clear water. Hold the lens downwards.
 - Exert only little pressure on the lens during cleaning to avoid scratches.



ATTENTION

Replacement of the protection glass only by authorized person. When removing the protective screen, always wear **protective glasses and -gloves**.

21 General technical data

Load	max. 500 Ω
Switching output OUT1/2	Open collector outputs 24 V, \leq 150 mA switching point / switch-back point, hysteresis \geq 1 K, switch-on/switch-off delay, NC / NO
Ambient temperature	0 - 65 $^{\circ}\text{C}$
IO-Link revision	V1.1, downwards compatible with V1.0
SIO mode	yes, supported
Transmission rate	COM3 (230,4 kBaud)
Storage temperature	-20 - 80 $^{\circ}\text{C}$
Permissible humidity	95 % r.h. max. (non-condensing)
Power requirement	18 - 30 V DC, Ripple \leq 200 mV
Housing material	Stainless steel
Weight	approx. 0.4 kg
Connectivity	Plug connector 5-pin M12 (A coded)
Protection	IP 65 to DIN 40050 with screwed-on plug
Configuration parameters	Emissivity ϵ 10 - 110 % Smoothing function t_{98} 0.1 - 999.9 s Peak hold function 0.1 - 999.9 s



To calculate the measuring field curve and the size of the measuring field at the distance relevant to you, please use our **measuring field calculator**, which you can find here:

www.keller.de/en/its/tools/measuring-field-calculator
Alternatively, you can simply scan the CR code opposite.

22 Device-specific technical data

PK 11 BF 1 / PK 18 BF 1 / PK 18 BF 2	
Temperature range	0 - 1000 °C
Sensor	Thermopile
Spectral sensitivity	8 - 14 µm
Focus distance	300 mm
Target spot diameter	11 mm
Analogue output OUT2	0(4) - 20 mA linear
Resolution current output	0.1 K + 0.005 % of selected range
Resolution temp. reading	0.1 K < 200 °C, 1 K ≥ 200 °C
Response time t_{90}	≤ 60 ms
Repeatability [#]	1 K
Measurement uncertainty [#]	0,75 % of temp. reading [°C] plus 2.0 K
Temperature coefficient [#]	0.1 K/K (for T<250°C), 0.04 %/K (for T>250°C) of temp. reading / K
Dimensions	M30 x 185 mm (without plug)

EN

PK 11 BF 2	
Temperature range	0 - 1000 °C
Sensor	Thermopile
Spectral sensitivity	8 - 14 µm
Focus distance	900 mm
Target spot diameter	33 mm
Analogue output OUT2	0(4) - 20 mA linear
Resolution current output	0.1 K + 0.005 % of selected range
Resolution temp. reading	0.1 K < 200 °C, 1 K ≥ 200 °C
Response time t_{90}	≤ 60 ms
Repeatability [#]	1 K
Measurement uncertainty [#]	0,75 % of temp. reading [°C] plus 2.0 K
Temperature coefficient [#]	0.1 K/K (for T<250°C), 0.04 %/K (for T>250°C) of temp. reading / K
Dimensions	M30 x 185 mm (without plug)

[#] Data applies to a thermally stabilised state.

PK 12 BF 1	
Temperature range	-30 - 300 °C
Sensor	Thermopile
Spectral sensitivity	8 - 14 µm
Focus distance	300 mm
Target spot diameter	18 mm
Analogue output OUT2	0(4) - 20 mA linear
Resolution current output	0.1 K + 0.005 % of selected range
Resolution temp. reading	0.1 K < 200 °C, 1 K ≥ 200 °C
Response time t_{90}	≤ 90 ms
Repeatability [#]	1 K
Measurement uncertainty [#]	0,75 % of temp. reading [°C] plus 2.0 K
Temperature coefficient [#]	0.1 K/K (for T<250°C), 0.04 %/K (for T>250°C) of temp. reading / K
Dimensions	M30 x 185 mm (without plug)

PK 14 BF 1	
Temperature range	0 - 500 °C
Sensor	Thermopile
Spectral sensitivity	8 - 14 µm
Focus distance	2.4:1 (90%) ≥ 1 m, calculated in the far field
Target spot diameter	
Analogue output OUT2	0(4) - 20 mA linear
Resolution current output	0.1 K + 0.005 % of selected range
Resolution temp. reading	0.1 K < 200 °C, 1 K ≥ 200 °C
Response time t_{90}	≤ 60 ms
Repeatability [#]	1 K
Measurement uncertainty [#]	0,75 % of temp. reading [°C] plus 2.0 K
Temperature coefficient [#]	0.1 K/K (for T<250°C), 0.04 %/K (for T>250°C) of temp. reading / K
Dimensions	M30 x 185 mm (without plug)

[#] Data applies to a thermally stabilised state.

PK 21 BF 1	
Temperature range	250 - 1600 °C
Sensor	InGaAs
Spectral sensitivity	1.0 - 1.7 μm
Focus distance	1500 mm
Target spot diameter	9.7 mm
Analogue output OUT2	0(4) - 20 mA linear
Resolution current output	0.1 K + 0.005 % of selected range
Resolution temp. reading	1 K
Response time t_{90}	≤ 2 ms T > 600 °C
Repeatability	1 K
Measurement uncertainty	0.3 % of temp. reading [°C] plus 2.5 K
Temperature coefficient	0.07 %/K of temp. reading / K
Dimensions	M30 x 210 mm (without plug)

EN

PK 24 BF 1	
Temperature range	250 - 1600 °C
Sensor	InGaAs
Spectral sensitivity	1.0 - 1.7 μm
Focus distance	5.1:1 (90%) ≥ 1 m, calculated in the far field
Target spot diameter	
Analogue output OUT2	0(4) - 20 mA linear
Resolution current output	0.1 K + 0.005 % of selected range
Resolution temp. reading	1 K
Response time t_{90}	≤ 2 ms T > 600 °C
Repeatability	1 K
Measurement uncertainty	0.3 % of temp. reading [°C] plus 2.0 K
Temperature coefficient	0.07 %/K of temp. reading / K
Dimensions	M30 x 210 mm (without plug)

PK 25 BF 1	
Temperature range	75 - 650 °C
Sensor	ext. InGaAs
Spectral sensitivity	1.8 - 2.4 µm
Focus distance	300 mm
Target spot diameter	7 mm
Analogue output OUT2	0(4) - 20 mA linear
Resolution current output	0.1 K + 0.005 % of selected range
Resolution temp. reading	0.1 K < 200 °C 1 K ≥ 200 °C
Response time t_{90}	≤ 2 ms T > 200 °C ≤ 15 ms T > 125 °C ≤ 50 ms T > 100 °C ≤ 200 ms T > 75 °C
Repeatability	2 K
Measurement uncertainty	0.3 % of temp. reading [°C] plus 4.0 K
Temperature coefficient	0.25 K/K (for T < 500 °C), 0.05 %/K (for T > 500 °C) of temp. reading / K
Dimensions	M30 x 210 mm (without plug)

PK 29 BF 1	
Temperature range	150 - 800 °C
Sensor	ext. InGaAs
Spectral sensitivity	1.8 - 2.2 µm
Focus distance	300 mm
Target spot diameter	7 mm
Analogue output OUT2	0(4) - 20 mA linear
Resolution current output	0.1 K + 0.005 % of selected range
Resolution temp. reading	1 K
Response time t_{90}	≤ 2 ms T > 300 °C ≤ 15 ms T > 200 °C ≤ 45 ms T > 150 °C
Repeatability	2 K
Measurement uncertainty	0.3 % of temp. reading [°C] plus 4.0 K
Temperature coefficient	0.25 K/K (for T < 500 °C), 0.05 %/K (for T > 500 °C) of temp. reading / K
Dimensions	M30 x 210 mm (without plug)

PK 31 BF 1	
Temperature range	500 - 2500 °C
Sensor	Si
Spectral sensitivity	0.78 - 1.06 µm
Focus distance	1500 mm
Target spot diameter	7.8 mm
Analogue output OUT2	0(4) - 20 mA linear
Resolution current output	0.1 K + 0.005 % of selected range
Resolution temp. reading	1 K
Response time t_{90}	≤ 2 ms (for T > 900 °C)
Repeatability	1 K
Measurement uncertainty	0.2 % of temp. reading [°C] plus 2.5 K
Temperature coefficient	0.07 %/K of temp. reading / K
Dimensions	M30 x 210 mm (without plug)

PK 35 BF 1	
Temperature range	450 - 1400 °C
Sensor	AlGaAs
Spectral sensitivity	0.82 - 0.93 µm
Focus distance	300 mm
Target spot diameter	6.5 mm
Analogue output OUT2	0(4) - 20 mA linear
Resolution current output	0.1 K + 0.005 % of selected range
Resolution temp. reading	1 K
Response time t_{90}	≤ 25 ms (für T > 500 °C) ≤ 2 ms (für T > 650 °C)
Repeatability	2 K
Measurement uncertainty	0.3 % of temp. reading [°C] plus 3.0 K
Temperature coefficient	0.07 %/K of temp. reading / K
Dimensions	M30 x 210 mm (without plug)

PK 41 BF 1	
Temperature range	300 - 1300 °C
Sensor	Thermopile
Spectral sensitivity	4.6 - 4.9 µm
Focus distance	400 mm
Target spot diameter	11 mm
Analogue output OUT2	0(4) - 20 mA linear
Resolution current output	0.1 K + 0.005 % of selected range
Resolution temp. reading	1 K
Response time t_{90}	≤ 90 ms
Repeatability [#]	2 K
Measurement uncertainty [#]	0.5 % of temp. reading [°C] plus 2.5 K
Temperature coefficient [#]	0.04 %/K of temp. reading / K
Dimensions	M30 x 200 mm (without plug)

[#] Data applies to a thermally stabilised state.

PK 42 BF 1	
Temperature range	500 - 2500 °C
Sensor	Thermopile
Spectral sensitivity	4.6 - 4.9 µm
Focus distance	400 mm
Target spot diameter	7 mm
Analogue output OUT2	0(4) - 20 mA linear
Resolution current output	0.1 K + 0.005 % of selected range
Resolution temp. reading	1 K
Response time t_{90}	≤ 60 ms
Repeatability [#]	4 K
Measurement uncertainty [#]	1.0 % of temp. reading [°C]
Temperature coefficient [#]	0.04 %/K of temp. reading / K
Dimensions	M30 x 200 mm (without plug)

PK 51 BF 1	
Temperature range	400 - 1400 °C
Sensor	Thermopile
Spectral sensitivity	3.8 - 4.0 µm
Focus distance	400 mm
Target spot diameter	11 mm
Analogue output OUT2	0(4) - 20 mA linear
Resolution current output	0.1 K + 0.005 % of selected range
Resolution temp. reading	1 K
Response time t_{90}	≤ 90 ms
Repeatability [#]	2 K
Measurement uncertainty [#]	1.0 % of temp. reading [°C]
Temperature coefficient [#]	0.04 %/K of temp. reading / K
Dimensions	M30 x 200 mm (without plug)

[#] Data applies to a thermally stabilised state.

PK 52 BF 1	
Temperature range	500 - 2000 °C
Sensor	Thermopile
Spectral sensitivity	3.8 - 4.0 µm
Focus distance	400 mm
Target spot diameter	7 mm
Analogue output OUT2	0(4) - 20 mA linear
Resolution current output	0.1 K + 0.005 % of selected range
Resolution temp. reading	1 K
Response time t_{90}	≤ 60 ms
Repeatability [#]	4 K
Measurement uncertainty [#]	1.0 % of temp. reading [°C]
Temperature coefficient [#]	0.04 %/K of temp. reading / K
Dimensions	M30 x 200 mm (without plug)

PK 72 BF 1	
Temperature range	400 - 2000 °C / 250 - 1700 °C
Sensor	Thermopile
Spectral sensitivity	CO ₂
Focus distance	400 mm
Target spot diameter	7 mm
Analogue output OUT2	0(4) - 20 mA linear
Resolution current output	0.1 K + 0.005 % of selected range
Resolution temp. reading	1 K
Response time t_{90}	≤ 60 ms
Repeatability [#]	4 K
Measurement uncertainty [#]	1.0 % of temp. reading [°C]
Temperature coefficient [#]	0.04 %/K of temp. reading / K
Dimensions	M30 x 200 mm (without plug)

[#] Data applies to a thermally stabilised state.

PKF 26 BF 1	
Temperature range	300 - 1600 °C
Sensor	InGaAs
Spectral sensitivity	1.0 - 1.7 μm
Focus distance	200 mm ... ∞ (adjustable)
Distance ratio	180:1 (measuring head PA 41.01)
Analogue output OUT2	0(4) - 20 mA linear
Resolution current output	0.1 K + 0.005 % of selected range
Resolution temp. reading	1 K
Response time t_{90}	≤ 2 ms T > 600 °C
Repeatability	2 K
Measurement uncertainty	0.3 % of temp. reading [°C] plus 2.5 K
Temperature coefficient	0.07 %/K of temp. reading / K
Permissible ambient temperature	Fiber optic metal 0 - 250 °C (measuring head)
Dimensions	M30 x 200 mm (electronics without plug) M30 x 67...86 mm (fiber optic measuring head)

PKF 26 BF 2	
Temperature range	300 - 1600 °C
Sensor	InGaAs
Spectral sensitivity	1.0 - 1.7 μm
Focus distance	1500 mm
Target spot diameter	7.2 mm (measuring head PKS 21.01)
Analogue output OUT2	0(4) - 20 mA linear
Resolution current output	0.1 K + 0.005 % of selected range
Resolution temp. reading	1 K
Response time t_{90}	≤ 2 ms T > 600 °C
Repeatability	2 K
Measurement uncertainty	0.3 % of temp. reading [°C] plus 2.5 K
Temperature coefficient	0.07 %/K of temp. reading / K
Permissible ambient temperature	Fiber optic metal 0 - 250 °C (measuring head)
Dimensions	M30 x 200 mm (electronics without plug) M30 x 67...86 mm (fiber optic measuring head)

PKF 26 BF 3	
Temperature range	300 - 1600 °C
Sensor	InGaAs
Spectral sensitivity	1.0 - 1.7 µm
Focus distance	120 mm ... ∞ (adjustable)
Distance ratio	100:1 (measuring head PA 41.05)
Analogue output OUT2	0(4) - 20 mA linear
Resolution current output	0.1 K + 0.005 % of selected range
Resolution temp. reading	1 K
Response time t_{90}	≤ 2 ms T > 600 °C
Repeatability	2 K
Measurement uncertainty	0.3 % of temp. reading [°C] plus 2.5 K
Temperature coefficient	0.07 %/K of temp. reading / K
Permissible ambient temperature	Fiber optic metal 0 - 250 °C (measuring head)
Dimensions	M30 x 200 mm (electronics without plug) M30 x 67...86 mm (fiber optic measuring head)

PKF 26 BF 4	
Temperature range	300 - 1600 °C
Sensor	InGaAs
Spectral sensitivity	1.0 - 1.7 µm
Focus distance	33 - 45 mm
Distance ratio	50:1 (measuring head PZ 41.18)
Analogue output OUT2	0(4) - 20 mA linear
Resolution current output	0.1 K + 0.005 % of selected range
Resolution temp. reading	1 K
Response time t_{90}	≤ 2 ms T > 600 °C
Repeatability	2 K
Measurement uncertainty	0.3 % of temp. reading [°C] plus 2.5 K
Temperature coefficient	0.07 %/K of temp. reading / K
Permissible ambient temperature	Fiber optic metal 0 - 250 °C (measuring head)
Dimensions	M30 x 200 mm (electronics without plug) M30 x 67...86 mm (fiber optic measuring head)

PKF 36 BF 1	
Temperature range	550 - 2500 °C
Sensor	Si
Spectral sensitivity	0.78 - 1.06 µm
Focus distance	200 mm ... ∞ (adjustable)
Distance ratio	190:1 (measuring head PA 41.01)
Analogue output OUT2	0(4) - 20 mA linear
Resolution current output	0.2 K + 0.03 % of selected range
Resolution temp. reading	1 K
Response time t_{90}	≤ 2 ms T > 900 °C
Repeatability	2 K
Measurement uncertainty	0.3 % of temp. reading [°C] plus 2.5 K
Temperature coefficient	0.07 %/K of temp. reading / K
Permissible ambient temperature	Fiber optic metal 0 - 250 °C (measuring head)
Dimensions	M30 x 200 mm (electronics without plug) M30 x 67...86 mm (fiber optic measuring head)

PKF 36 BF 2	
Temperature range	550 - 2500 °C
Sensor	Si
Spectral sensitivity	0.78 - 1.06 µm
Focus distance	1080 mm
Distance ratio	6.9 mm (measuring head PKS 21.01)
Analogue output OUT2	0(4) - 20 mA linear
Resolution current output	0.2 K + 0.03 % of selected range
Resolution temp. reading	1 K
Response time t_{90}	≤ 2 ms T > 900 °C
Repeatability	2 K
Measurement uncertainty	0.3 % of temp. reading [°C] plus 2.5 K
Temperature coefficient	0.07 %/K of temp. reading / K
Permissible ambient temperature	Fiber optic metal 0 - 250 °C (measuring head)
Dimensions	M30 x 200 mm (electronics without plug) M30 x 67...86 mm (fiber optic measuring head)

PKF 36 BF 3	
Temperature range	550 - 2500 °C
Sensor	Si
Spectral sensitivity	0.78 - 1.06 µm
Focus distance	120 mm ... ∞ (adjustable)
Distance ratio	100:1 (measuring head PA 41.05)
Analogue output OUT2	0(4) - 20 mA linear
Resolution current output	0.2 K + 0.03 % of selected range
Resolution temp. reading	1 K
Response time t_{90}	≤ 2 ms T > 900 °C
Repeatability	2 K
Measurement uncertainty	0.3 % of temp. reading [°C] plus 2.5 K
Temperature coefficient	0.07 %/K of temp. reading / K
Permissible ambient temperature	Fiber optic metal 0 - 250 °C (measuring head)
Dimensions	M30 x 200 mm (electronics without plug) M30 x 67...86 mm (fiber optic measuring head)

PKF 36 BF 4	
Temperature range	550 - 2500 °C
Sensor	Si
Spectral sensitivity	0.78 - 1.06 µm
Focus distance	33 - 45 mm
Distance ratio	50:1 (measuring head PZ 41.18)
Analogue output OUT2	0(4) - 20 mA linear
Resolution current output	0.2 K + 0.03 % of selected range
Resolution temp. reading	1 K
Response time t_{90}	≤ 2 ms T > 900 °C
Repeatability	2 K
Measurement uncertainty	0.3 % of temp. reading [°C] plus 2.5 K
Temperature coefficient	0.07 %/K of temp. reading / K
Permissible ambient temperature	Fiber optic metal 0 - 250 °C (measuring head)
Dimensions	M30 x 200 mm (electronics without plug) M30 x 67...86 mm (fiber optic measuring head)

PKL 11 BF 1	
Temperature range	0 - 1000 °C
Sensor	Thermopile
Spectral sensitivity	8 - 14 µm
Focus distance	295 mm
Target spot diameter	9 mm
Analogue output OUT2	0(4) - 20 mA linear
Resolution current output	0.1 K + 0.005 % of selected range
Resolution temp. reading	0.1 K < 200 °C, 1 K ≥ 200 °C
Response time t_{90}	≤ 60 ms
Repeatability [#]	1 K
Measurement uncertainty [#]	0.75 % of temp. reading [°C] plus 2.0 K
Temperature coefficient [#]	0.1 K/K (for T<250°C), 0.04 %/K (for T>250°C) of temp. reading / K
Dimensions	M30 x 200 mm (without plug)

PKL 11 BF 2	
Temperature range	0 - 1000 °C
Sensor	Thermopile
Spectral sensitivity	8 - 14 µm
Focus distance	89 mm
Target spot diameter	3.2 mm
Analogue output OUT2	0(4) - 20 mA linear
Resolution current output	0.1 K + 0.005 % of selected range
Resolution temp. reading	0.1 K < 200 °C, 1 K ≥ 200 °C
Response time t_{90}	≤ 60 ms
Repeatability [#]	1 K
Measurement uncertainty [#]	0.75 % of temp. reading [°C] plus 2.0 K
Temperature coefficient [#]	0.1 K/K (for T<250°C), 0.04 %/K (for T>250°C) of temp. reading / K
Dimensions	M30 x 200 mm (without plug)

[#] Data applies to a thermally stabilised state.

PKL 28 BF 1	
Temperature range	250 - 1600 °C
Sensor	InGaAs
Spectral sensitivity	1.0 - 1.7 µm
Focus distance	210 mm
Target spot diameter	1.4 mm
Analogue output OUT2	0(4) - 20 mA linear
Resolution current output	0.1 K + 0.005 % of selected range
Resolution temp. reading	1 K
Response time t_{90}	≤ 2 ms T > 600 °C
Repeatability	1 K
Measurement uncertainty	0.3 % of temp. reading [°C] plus 2.5 K
Temperature coefficient	0.07 %/K of temp. reading / K
Dimensions	M30 x 235 mm (without plug)

PKL 28 BF 2	
Temperature range	250 - 1600 °C
Sensor	InGaAs
Spectral sensitivity	1.0 - 1.7 µm
Focus distance	1000 mm
Target spot diameter	6.7 mm
Analogue output OUT2	0(4) - 20 mA linear
Resolution current output	0.1 K + 0.005 % of selected range
Resolution temp. reading	1 K
Response time t_{90}	≤ 2 ms T > 600 °C
Repeatability	1 K
Measurement uncertainty	0.3 % of temp. reading [°C] plus 2.5 K
Temperature coefficient	0.07 %/K of temp. reading / K
Dimensions	M30 x 235 mm (without plug)

PKL 29 BF 1	
Temperature range	180 - 1200 °C
Sensor	ext. InGaAs
Spectral sensitivity	1.8 - 2.2 µm
Focus distance	290 mm
Target spot diameter	6.2 mm
Analogue output OUT2	0(4) - 20 mA linear
Resolution current output	0.1 K + 0.005 % of selected range
Resolution temp. reading	1 K
Response time t_{90}	≤ 2 ms T > 300 °C ≤ 10 ms T > 250 °C ≤ 25 ms T > 180 °C
Repeatability	1 K
Measurement uncertainty	0.3 % of temp. reading [°C] plus 4.0 K
Temperature coefficient	0.25 K/K (for T < 500 °C), 0.05 %/K (for T > 500 °C) of temp. reading / K
Dimensions	M30 x 235 mm (without plug)

EN

PKL 38 BF 1	
Temperature range	500 - 2500 °C
Sensor	Si
Spectral sensitivity	0.78 - 1.06 µm
Focus distance	210 mm
Target spot diameter	1.2 mm
Analogue output OUT2	0(4) - 20 mA linear
Resolution current output	0.1 K + 0.005 % of selected range
Resolution temp. reading	1 K
Response time t_{90}	≤ 2 ms T > 900 °C
Repeatability	1 K
Measurement uncertainty	0.2 % of temp. reading [°C] plus 2.5 K
Temperature coefficient	0.07 %/K of temp. reading / K
Dimensions	M30 x 235 mm (without plug)

PKL 38 BF 2	
Temperature range	500 - 2500 °C
Sensor	Si
Spectral sensitivity	0.78 - 1.06 μm
Focus distance	1000 mm
Target spot diameter	5.6 mm
Analogue output OUT2	0(4) - 20 mA linear
Resolution current output	0.1 K + 0.005 % of selected range
Resolution temp. reading	1 K
Response time t_{90}	≤ 2 ms $T > 900$ °C
Repeatability	1 K
Measurement uncertainty	0.2 % of temp. reading [°C] plus 2.5 K
Temperature coefficient	0.07 %/K of temp. reading / K
Dimensions	M30 x 235 mm (without plug)

23 Accessories

A range of mechanical and electrical accessories are available for mounting the pyrometers in industrial environments.

For the selection of the components use the following link:

<https://www.keller.de/en/its/pyrometer/accessories>

24 Default settings

The default settings can be found in the descriptions of the IODD. You can find them on the respective device pages on our homepage www.keller.de/en/its/pyrometer

25 Copyright

The licence information of the Open Source libraries used can be found in the media center on our homepage www.keller.de/en/its

Copyright prohibits the reproduction or distribution of this instruction manual, including text, photographs or images contained herein, in whole or in part, for any purpose whatsoever, without prior consent of the author. This applies to any form of mechanical or electronic reproduction as well as to electronic transmission in any form through any medium.

Please note:

Unless otherwise stated in this instruction manual, the instruments described herein are subject to change without prior notice, particularly modifications for the sake of technological advancement.

© 2024 KELLER HCW GmbH
Carl-Keller-Straße 2-10
D-49479 Ibbenbüren-Laggenbeck
Germany
www.keller.de/its

