

KELLER

*infrared
temperature
solutions*

ITS

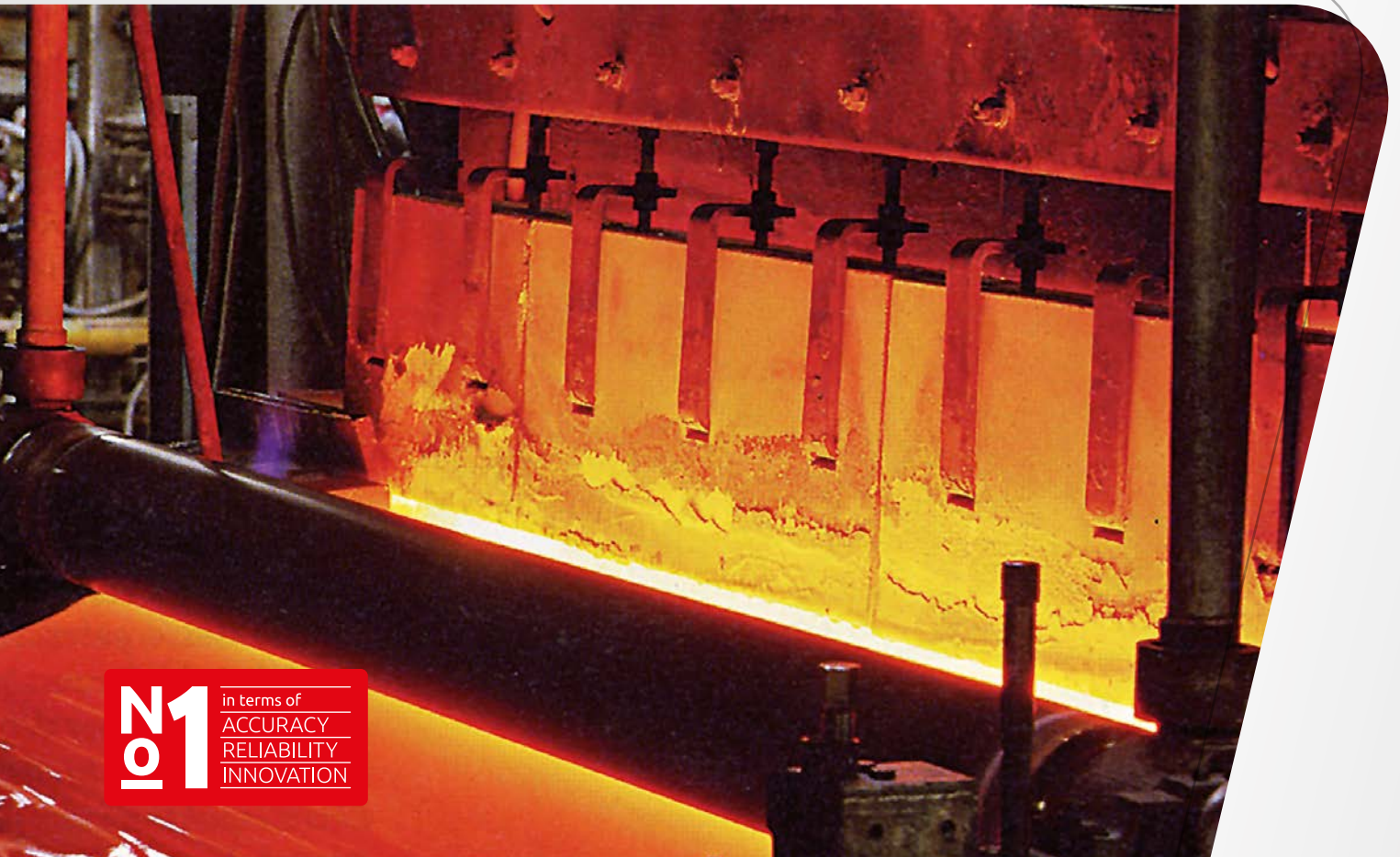

no1 in terms of
ACCURACY
RELIABILITY
INNOVATION

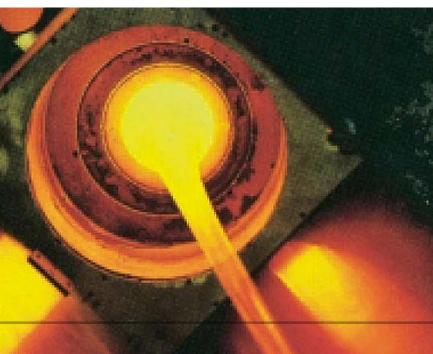

Application Glass

Basics and applications - pyrometric temperature measurements in the glass industry

Temperature measurements are a vital factor to monitor and to optimise the energy-intensive glass melting processes. Therefore, non-contact pyrometric measurements are of great significance for the determination of the glass temperature as the most important indicator in the glass forming process. A temperature variation of 1% in the processing area of the majority of glass types already causes a variation in viscosity of approximately 1%.

Often contact measurements with thermocouples with ceramic sheaths are still used to monitor the crown temperature during the glass melting process.

However, rapid ageing and limited service life require periodic accuracy checks with portable pyrometers. Thermocouples with platinum sheaths are used for molten glass in the tank and feeder. More and more, thermocouples are being replaced by wear-free pyrometers.

To avoid damage to the product, only a non-contact temperature measurement method can be employed to monitor the temperature in glass forming.

Both portable and stationary pyrometers can bring about large rationalisation effects.

This is especially true

- when starting up and running glass production lines
- when changing over to a different line of products
- for quality control of manufactured products
- when manufacturing glass laboratory equipment such as test tubes and beakers
- when conducting industrial research for the flat glass, container glass or household glass sectors
- for subsequent finishing and processing of glass products, such as ampoules and glass-to-metal bonds

Typical measuring points

In the glass industry, the locations for pyrometer temperature measurements can be categorised according to their thermal radiation characteristics:

- Black bodies are measured by pyrometers which “see” through a small eyehole into a uniformly heated cavity (fuel-heated melting tanks). A thermocouple with a protection tube can be installed at the crown or at the side wall of the tank furnace, or the pyrometer can “look” into a closed ceramic annealing tube.
- Opaque emitters or grey bodies. In this case, the pyrometer is aimed at metallic surfaces, e.g. at the open inside of moulds. The thermal energy is only emitted from the mould surface.
- Transparent radiation sources where the thermal radiation is emitted from the surface and from deeper glass layers as well. The depth at which the pyrometer can detect the radiation depends on the spectral absorption coefficient of the hot glass and the pyrometer’s spectral range.

Ultimately, one must distinguish between temperature measurements with continuous or discontinuous signal sequences (temperature of gobs, moulds and products). Discontinuous measurements require pyrometers with small response times and a peak picker.

Glass as a transparent volume radiating source

When measuring black or grey bodies, the primary criteria for selecting a pyrometer are temperature range, target spot diameter, measuring distance and response time. For transparent glass applications, the thickness of the glass and the pyrometer’s measuring depth must also be considered. This depends on the pyrometer’s spectral range and the spectral absorption coefficient of the particular type of glass and of the glass temperature.

Glass as a grey body

In general, the relationship between reflectance ρ , absorption coefficient α and transmittance τ can be expressed in the following equation:

$$\rho(\lambda, T) + \alpha(\lambda, T) + \tau(\lambda, T) = 1 \quad (1)$$

If a glass medium, due to its thickness, is opaque for certain parts of the IR radiation, in other words, if the transmissivity is negligibly low ($\tau < 0.01$), then the following equation based on Kirchhoff’s law of thermal radiation will be true for emissivity ϵ :

$$\epsilon(\lambda, T) = 1 - \rho(\lambda, T) \quad (2)$$

In these cases, the measured glass object is a grey body. The spectral development of reflectivity as per equation (2) generally indicates emissivity as a function of wavelength λ .

Fig. 1 shows the measured spectral reflectivity $\rho(\lambda)$ for borosilicate glass} and the spectral emissivity $\epsilon(\lambda)$ as calculated using equation (2) as a function of wavelength, taking into account the negligibly low transmissivity $\tau(\lambda) < 0.01$.

In addition, the chart shows some spectral ranges of pyrometers, each sensitive to the appropriate emissivity setting $\epsilon(\lambda)$ for borosilicate glass.

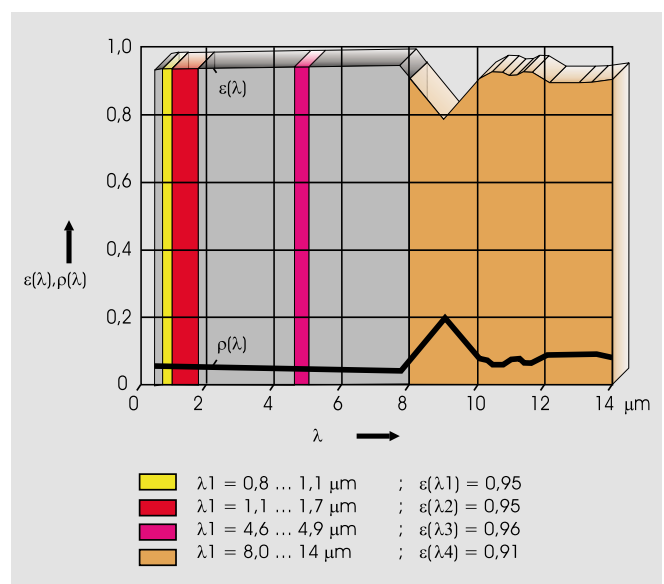

Fig. 1: Spectral reflectivity $\rho(\lambda)$ for borosilicate glass 3.3, taking into account the negligibly low transmissivity $\tau(\lambda) < 0.01$ as calculated using equation 2, calculated spectral emissivity $\epsilon(\lambda)$, and spectral ranges of pyrometers with the appropriate emissivity setting $\epsilon(\lambda)$ for borosilicate glass.

One can see that wavelengths between 0.5 and 7.8 μm exhibit a nearly constant emissivity between 0.95 and 0.96.

For the spectral range 8 – 14 μm an average emissivity value $\epsilon = 0.91$ should be selected.

Unlike metal surfaces where the spectral emissivity decreases with increasing wavelengths or is fluctuating or varies in relation to temperature and time, clear glass surfaces with negligible transmissivity in the spectral range from 0.5 to 7.8 μm may be regarded as grey bodies. The clear glass surface is not subject to perceptible changes as it is, for example, the case with metal surfaces undergoing oxidation.

¹⁾ Borosilicate glass 3.3 (ISO-3585) can be used for laboratory instruments under high thermal stress, electron and x-ray tubes, for pipings and technical plants.

Temperature measurements independent of the glass thickness

The conditions for the required glass thickness with a negligible transmissivity of $\tau < 0.01$ are defined by the spectral absorption coefficient $\alpha(\lambda, T)$ of the measured type of glass at a specific glass temperature.

From the law of absorption

$$I = I_0 \cdot e^{-[\alpha(\lambda, T) \cdot X]} \quad (3)$$

follows at approximately full absorption

$$I/I_0 = 0.01 = e^{-[\alpha(\lambda, T) \cdot X_{99}]} \quad (4)$$

the relation for the product of the exponent

$$\alpha(\lambda, T) \cdot X_{99} = 4.6 \quad (5)$$

resp. after conversion

$$X_{99} = \frac{4.6}{\alpha(\lambda, T)} \quad (6)$$

$\alpha(\lambda, T)$ here is the spectral absorption coefficient of the measured glass at the specific glass temperature while X_{99} defines the glass thickness at which 99 % of the radiation I_0 from the depth X_{99} is absorbed in the glass on its way to the glass surface.

This characteristic value X_{99} is also called measuring depth of the pyrometer and it is like the absorption coefficient a function of the wavelength λ and the glass temperature T . The pyrometer receives 99% of the signal intensity from this depth.

Fig. 2 demonstrates the spectral measuring depth X_{99} for borosilicate glass at glass temperatures of 600, 1000 and 1200 °C. The chart also illustrates the spectral ranges of a number of pyrometers and the maximum measuring depths for borosilicate glass.

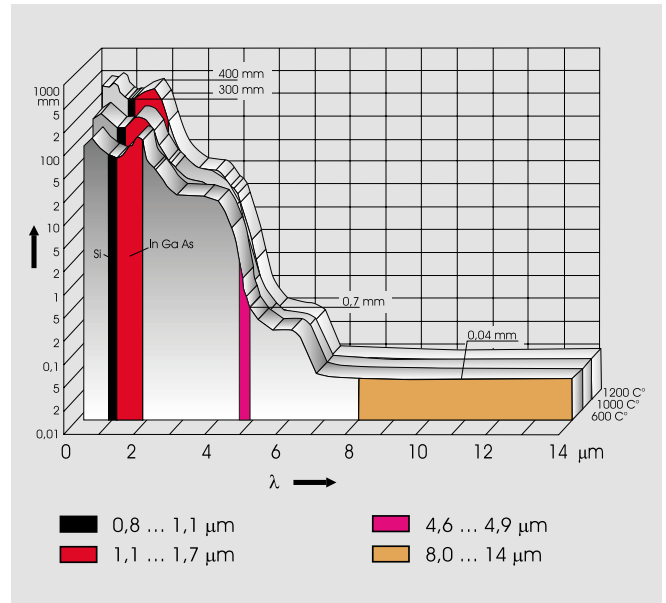

Fig. 2: Measurement depth X_{99} , calculated using spectral absorption coefficient $\alpha(\lambda)$ for borosilicate glass 3.3 as a function of wavelength λ at glass temperatures of 600, 1000 and 1200 °C. Additionally listed are the spectral ranges of a number of pyrometers with their maximum measuring depths.

For the calculation of the spectral measuring depth X_{99} , glass with homogeneous temperature distribution was assumed. In the wavelength range 0.5 to 2.0 μm which is the range of free transmission for uncoloured glass, the measuring depth X_{99} will be between 90 to 400 mm, depending on temperature.

At wavelengths >2.0 μm, these temperature gradients will decrease at longer wavelengths.

When a pyrometer with Si sensors (0.8 – 1.1 μm) is employed, the measuring depth X_{99} for glass temperatures is approximately

- 90 mm at 600 °C (the glass will appear dark red)
- 170 mm at 1000 °C
- 300 mm at 1200 °C

Pyrometers with a InGaAs sensor (1.1 – 1.7 μm) will measure at a somewhat greater measuring depth than pyrometers with Si sensor.

Pyrometers with a spectral range of 4.6 to 4.9 μm have a measuring depth X_{99} of a maximum of 0.7 mm.

Pyrometers with a spectral range >8 μm will only reach X_{99} at a depth of 0.04 mm. These devices capture merely the surface temperature and react on effects of convection.

Fig. 3 shows the large differences in the spectral measuring depth X_{99} of sheet glass and green glass in the spectral range 0.5 to 3 μm at glass temperatures of 20, 1250 and 1300 °C.

While the measuring depth of sheet glass at 1300 °C more or less equals that of borosilicate glass, the measuring depth of green glass, due to its larger absorption coefficient, is only 6 mm at a temperature of 20 °C and 12 mm at 1250 °C.

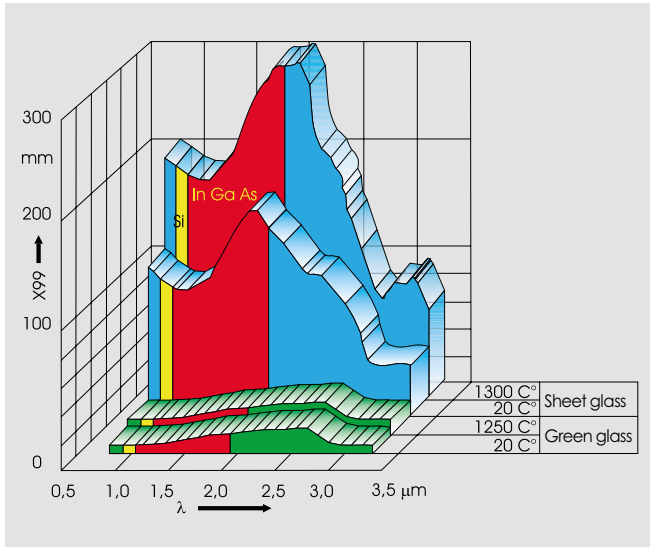

Fig. 3: Measuring depth X_{99} as a function of wavelength λ for sheet glass at 20 °C and 1300 °C and for green glass at 20 °C and 1250 °C showing the spectral ranges of pyrometers with Si sensor or InGaAs sensor.

This means that even pyrometers with Si sensors cannot "see" very deep into green glass. As a rule, glass objects are non-transparent at wavelengths $>4 \mu\text{m}$, thus at this spectral range, the shallow measuring depth X_{99} for borosilicate glass as shown in fig. 2, will also apply to sheet glass and green glass.

Fig. 4 illustrates the standardised radiant energy $E(D/X_{99})/E_{100} \%$ received by a single channel pyrometer with Si sensor as a function

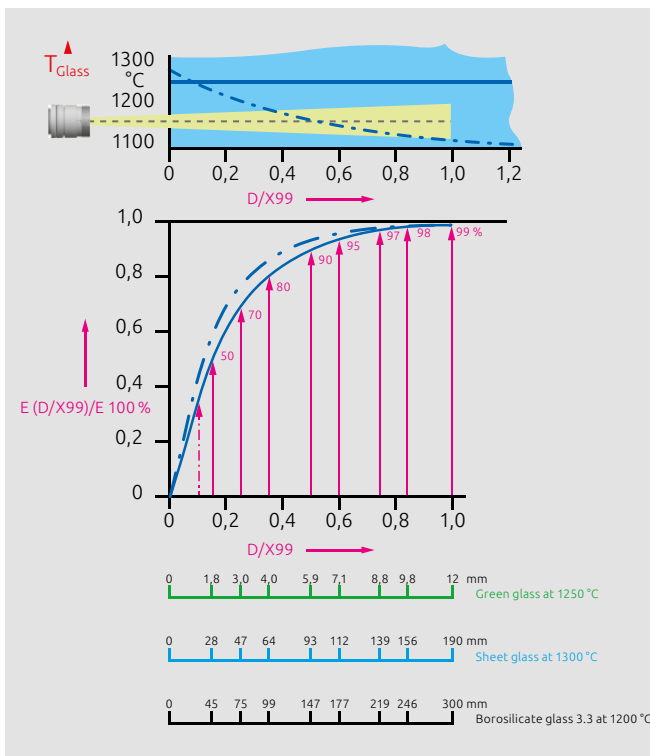

Fig. 4: Standardised radiant energy $E(D/X_{99})/E_{100} \%$ received by a single channel spectral pyrometer with Si-sensor as a function of the standardised glass depth D/X_{99} for various types of glass at homogeneous and inhomogeneous temperature gradients within the glass object.

of the standardised glass depth D/X_{99} for green glass, sheet glass and borosilicate glass at homogeneous and inhomogeneous temperature gradients with the glass object.

The pyrometer detects 50% of the energy from the glass surface and from layers below the surface down to a depth which is commensurate to one sixth of the measuring depth X_{99} . When the temperature distribution is inhomogeneous (surface glass is hotter than layers below the surface), these 50% will be even shallower (indicated by the dot-dash line).

Selecting a pyrometer according to glass thickness

Single channel/spectral pyrometer

In order to obtain a representative signal for the glass temperature, one must employ a spectral pyrometer where the maximum measuring depth is smaller than the glass thickness at the measuring point.

If the glass thickness is less than the pyrometer's measuring depth, the pyrometer will more or less "see" through the glass object and pick up radiant energy from the background. Variations in the glass thickness will distort the signal, for example when a single channel spectral pyrometer with Si sensor is aimed horizontally through a gob.



Pyrometers of the CellaTemp PK 41/42 series with their spectral sensitivity of 4.6 – 4.9 μm measure temperatures just below the glass surface.

Because a gob of colourless glass with a diameter between 20 and 80 mm will constitute a measuring depth of 300 mm for Si-sensor pyrometers, the temperature reading will depend on the glass thickness.

Nonetheless, an accurate temperature reading can be obtained if the pyrometer is aimed diagonally at the gob of molten glass as it is dispensed from the gob feeder or a two-colour pyrometer with Si sensor can be employed.

If, however, the measuring depth is substantially smaller than the glass thickness, the pyrometer will predominantly pick up thermal energy at the uppermost glass layers just below the surface which might be subject to strong convection currents. The reading obtained then mainly represents surface disturbances. Therefore, a pyrometer which measures close to the surface (4.6 to 4.82 μm) at a measuring depth of 0.7 mm at the workcell of a ball gatherer with a glass height of approximately 800 mm is not suitable.

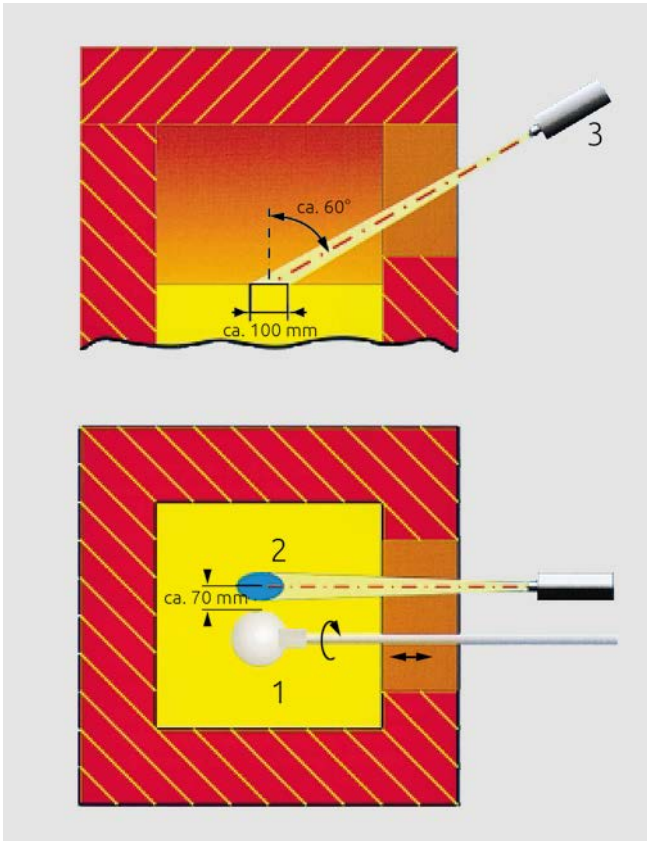

Fig. 5: Arrangement for measuring temperature in the workcell of a ball gatherer (1 gathering ball is plunged into the tank of molten glass, 2 target spot, 3 pyrometer).

Fig. 5 demonstrates that severe convection interferences at the glass surface can occur due to the large size of the extraction

opening. Glass extracted for processing from lower depths will not be affected.

The control loop of an electric overhead heater, for example, is extremely sensitive to this external interference. The heater will shut off when the gathering ball, coated with molten glass, enters the gathering bay, and turn on again when the ball gatherer is withdrawn. This will produce misleading temperature data.

This source of error can be eliminated by a pyrometer with Si sensor with a measuring depth of approx. 300 mm. Even when tilted at an angle of 30°, this pyrometer will “see” 150 mm into the glass target.

When buying a pyrometer, always make sure to select a pyrometer whose measuring depth X99 is less than the glass thickness, always considering the highest possible value for the measuring depth for the type of glass measured. This will prevent the sensor from “looking through” the glass at any temperature which would result in a glass thickness related measuring error.

Two-channel/two-colour pyrometers

Two-colour pyrometers should be employed when the thickness of the measured glass is less than the maximum depth X99, but greater than one sixth of that value. At that thickness, both channels will still receive 50 % of the thermal radiation (Fig. 4). The two-colour pyrometer will determine the true temperature value, because signal attenuation will be the same at both wavelengths (numerator and denominator) and the quotient will remain constant.

Table 1 lists various pyrometers with their respective spectral and temperature ranges and shows the depth X99 for different kinds of glass and some typical applications for spectral and two-colour pyrometers.

Temperature	Wavelength	Type of glass	Max. measuring depth X99 for this type of glass	Locations/applications at a glass thickness D	
				D > X99	1/6 X99 < D < X99
				Spectral pyrometer	Quotienten-Pyrometer
700 ... 3000 °C	0.8 ... 1.1 µm	Green glass	12 mm	Gob	Gob
		Sheet glass	190 mm		
		Borosilicate glass	300 mm		
250 ... 2500 °C	1.1 ... 1.7 µm	Green glass	24 mm	Gob, mould	Gob
		Sheet glass	290 mm		
		Borosilicate glass	400 mm		
300 ... 2500 °C	4.6 ... 4.9 µm	Green glass	0.7 mm	Blow pipe tip, blow pipe head, "onion", parison, article	
		Sheet glass			
		Borosilicate glass			
0 ... 1000 °C	8.0 ... 14.0 µm	Green glass	0.04 mm	Moulds, article (before and after lehr) transport belts	
		Sheet glass			
		Borosilicate glass			

Table 1: Pyrometers with their respective spectral and temperature ranges, max. measuring depths X99, for different kinds of glass and some typical measuring locations/ applications for spectral and two-colour pyrometers.

Pyrometer types and typical applications in the glass industry

The scope of KELLER pyrometers and accessories offers suitable solutions for all measuring spots.

Stationary pyrometers

Spectral pyrometers with Si or InGaAs sensors are especially suitable for measuring glass temperatures at the **melting tank, in workcells and feeder**, due to their large measuring depth for colourless glass and their temperature ranges from 250 °C to 3000 °C.

The CellaTemp PA 20 / 30 with sighting aid or the CellaTemp PK 21 / 31 without sighting aid is preferable for measuring glass temperatures at **workcells of the ball gatherer**. From a safe distance, this pyrometer "sees" through the orifice into the glass melt (Fig. 5). This pyrometer features a peak picker function to smooth any sporadic signal fluctuations caused by the movement of the gathering ball in the pyrometer's optical path.

The CellaTemp PA 36 or CellaTemp PK 36 with separate optical sensor head is especially suitable for measurements at the **feeders**. An optical fibre cable connects the small sensor head (Ø 12 mm or Ø 30 mm) to the electronics unit. The device can be used without cooling at ambient temperatures up to 250 °C.



CellaTemp PKF 36 / 66 with separate sensor head and optical fibre cable.

Ceramic sighting tubes and air purging devices serve to keep the pyrometer optics clean and help extend maintenance intervals. For inspection purposes, the sensor head can be easily disconnected in seconds without the use of tools.

With green glass, spectral pyrometers with Si sensor can measure at a maximum depth of 12 mm. Thus the **CellaTemp PA30 with through-the-lens-sighting or integrated video camera** can be employed for measuring green glass gob temperatures when the gob diameter is >15 mm. The peak picker function can compensate for signal interruptions during gob cutting.

The spectral pyrometers CellaTemp PA 20/21 with InGaAs sensors can measure deeper into colourless glass and green glass than pyrometers with Si sensors.

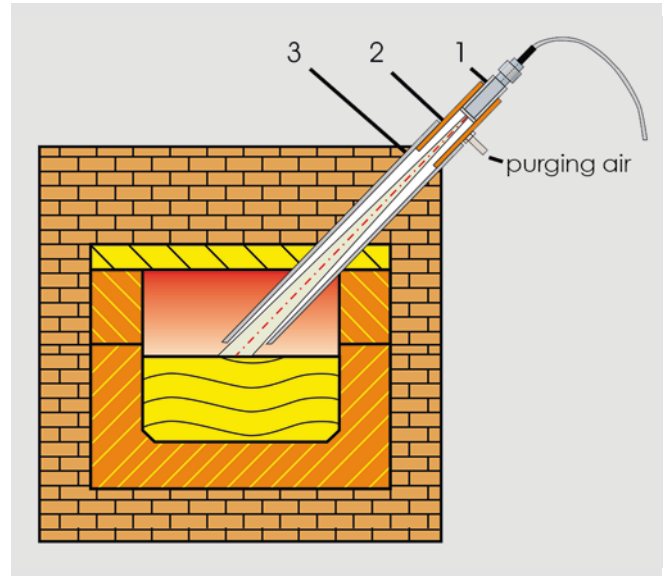

Fig. 6: Example of a mounting assembly for the fibre optics pyrometer CellaTemp PKF with separate sensor head at a feeder. The sensor head 1 is mounted in an intermediate tube 2 with air purge connection; the intermediate tube is fastened to the sighting tube 3 which is built into the wall.

Due to its spectral range (1.1 - 1.7 µm) temperatures from 250 °C upwards can be detected. These pyrometers are therefore also suitable to **measure temperatures of moulds and blow moulds**.

However, since the surface characteristics of the mould will vary over time from shiny to dull as well as before and after each lubrication, their surface emissivity will fluctuate greatly. To eliminate these emissivity fluctuations, a cavity should be drilled into the outside of the mould into which the pyrometer can be aimed.

When the cavity's drill depth is at least six times the diameter, the pyrometer will "see" into what can be considered a grey body with an emissivity of 0.95.

In this way, regardless of the cast iron mould's inner surface condition, a stationary pyrometer can obtain a reproducible and representative temperature value for the mould.



CellaTemp PA 21 / 31 / 41 with fibre optics sensor head Ø 30 mm and integrated laser spot light to display the exact position and size of the target area.

There is indeed a temperature difference between the mould's inner surface and the temperature in the drilled cavity. This temperature difference will remain a constant value. The closer the bottom of the drilled cavity is to the inner surface down to a remaining thickness of approx. 4 mm, the smaller is the difference between these temperatures.

The CellaTemp PA 21 or CellaTemp PKF 26 with optical fibre cable and optical sensor head is ideal to measure mould temperatures. The small sensor head can be mounted to a convenient location near the press or the press-and-blow machine. The spot light feature illuminates the target spot and indicates the exact spot diameter in true size. The pyrometer is then adjusted to the "measuring cavity" (Fig. 7).

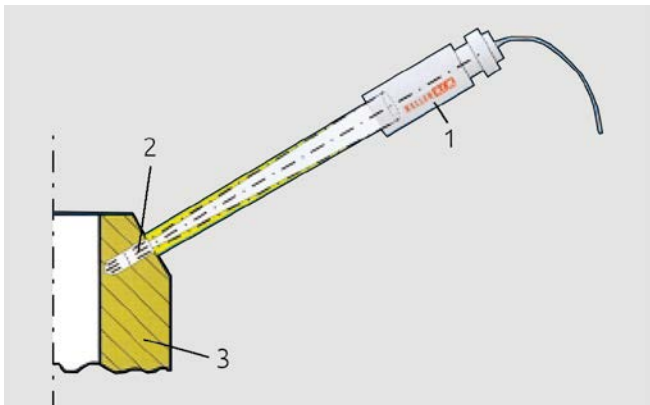

Fig. 7: The pyrometer with optical sensor head and spot light 1 is adjusted to the "measuring cavity" 2 of a press-and-blow mould 3.

The infrared temperature switch CellaSwitch PKS 21 can detect glass residue in the moulds within milliseconds. Production downtimes and expensive repairs of tools caused by glass stuck to the mould are thereby eliminated. Within the measuring range 300 to 1300 °C, the switching point can be configured with keys on the display.

The two-colour pyrometers CellaTemp PA40 / 41 / 43, CellaTemp PK 63 / 68 and CellaTemp PKF 66 with measuring ranges from 450 – 3000 °C can be employed in the following situations:

- The glass thickness D at the measured spot is less than the pyrometer's measuring depth $X99$ for glass but more than one sixth of that value, therefore is $1/6 \cdot X99 < D < X99$
- When it is required to measure inductively heated metal parts that will be sealed into the rear side of the glass and it is for technological reasons only possible to measure through thick and often tinted glass.

The two-colour pyrometers PA 40/43 and CellaTemp PK 63/68 are used to measure the temperature of colourless gobs which have a diameter of >40 mm and are aimed at horizontally.

The panorama pyrometers CellaTemp PA 43 and CellaTemp PK 63 have a rectangular measurement area. This facilitates the alignment on the gob considerably. As long as the gob remains within the rectangular measurement area, the pyrometer provides a correct reading.

With a gob diameter of 30 – 40 mm, the pyrometer should be aimed towards the gob at an angle of 30° from the horizontal position to "enlarge" the glass thickness.

The signal interruptions during periodic gob cutting are compensated for by the integrated peak picker.

Due to the low measuring depth of X99 < 0.7 mm, the pyrometers CellaTemp PA 15 and CellaTemp PK 41/42 with a wavelength from 4.6 to 4.9 µm and ranges from 300-2500 °C measure glass surface temperatures or the mixed temperature of a near-surface glass layer. They are especially suitable for temperature monitoring of relatively thin-walled objects (glass thickness > 1 mm) of flat glass, container glass or household glassware products in processing and cooling areas.

All technological-related temperature changes are verifiable when measuring the "onion" temperature at Danner mandrels.

When measuring the tip of a blowpipe, the pyrometer signal is a representative magnitude for the temperature condition of the glass surface and the muffle chamber. The peak picker of the pyrometer eliminates the signal variations that appear periodically in function of the speed of the blowpipe.

Due to the low measuring depth of X99 < 0.04 mm, the pyrometers CellaTemp PA 10 and CellaTemp PK 11 with a wavelength of 8 – 14 µm and a range from 0 – 1000 °C measure only the surface temperature of glass (glass skin temperature). They are therefore used for thin-walled glass (thickness > 0.1 mm).

With its focusable lens and its high optical resolution, the CellaTemp PA 10 is especially suitable for small objects, such as household glassware or for large distances to the target. The compact CellaTemp PK 11 is often used for temperature monitoring of glass products on conveyor belts coming from the Lehr as well as before and after the treatment of glass products.



The pyrometers of the PA series feature focusable through-the-lens sighting or a video camera with target marker to facilitate aiming.

The stationary pyrometers of the PA series are characterised by their focusable optics or, optionally, through-the-lens sighting or a colour video camera. The marked target, as seen through the viewfinder or on the monitor, indicates the true size of the spot measured.

This feature facilitates pyrometer alignment, particularly when measuring small objects or when looking through narrow openings.

In addition, the measuring range of the PA pyrometers can be adjusted both at the instrument itself as well as via a standard USB or

RS 485 interface, allowing for an optimal adaptation to the measuring point from the control room.

The instruments of the **compact PK pyrometer series** are merely 30 mm in diameter and are thus ideal when working in confined areas. Housed in an IP 65 stainless steel enclosure they can be employed in extremely harsh industrial conditions.

The measured temperature can be read on the display directly on site. All parameters and functions can be configured by keys on the instrument.

All KELLER pyrometers work with sensors receiving unmodulated radiation, i.e. the devices operate without mechanical moving parts and are maintenance-free and have a long service life.

The range of stationary pyrometers is enhanced by a comprehensive selection of mounting fittings and accessories.

Portable pyrometers

The portable pyrometers correspond to the stationary instruments in terms of temperature and wavelength range. These handhelds are suitable for temperature measuring tasks at spots where comparable stationary pyrometers are used.

The mobile devices of the CellaPort PT series are also used for temperature verification in the crown or in the upper section of melting tanks. Temperature deviations of thermocouples due to ageing, depending upon operating conditions (installation mode, temperature, energy carrier, protective tube and glass type) can easily be checked with these portable pyrometers.

The CellaPort PT series are characterised by the following features:

- Parallax-free and true-to-side through-the-lens sighting with diopter correction and extended pupil distance
- Reflex optics with very large field of view and precise target marking to visualize the exact measuring area
- Premium quality focusable optics with precise lenses for high optical resolution
- 10 models to match with a large number of applications
- ATD function for automatic detection of objects
- Spectral pyrometers and two-colour pyrometers
- Robust aluminium housing
- Patented traffic light function (SSI – Signal Strength Indicator) in the view finder indicates the correct distance to the target and sufficient signal strength
- Optionally as panorama pyrometer® with a rectangular measurement area

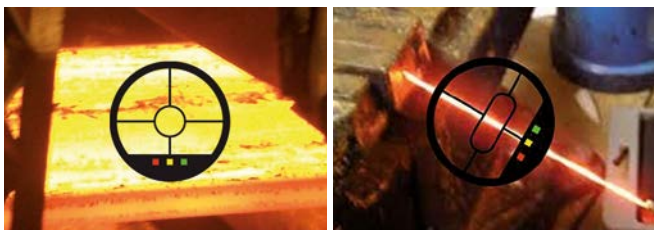

Patented traffic light function in the view finder of the CellaPort PT

The **CellaPort PT 120** or **CellaPort PT 130** with measuring ranges from 250 – 2000 °C or 500 – 2500 °C is ideal for **temperature checks** in the **upper furnace section** and for **molten glass** in **melting tanks, workcells and feeders** and to check **thermocouples in the crown**.



Portable pyrometer of the CellaPort PT series

The **CellaPort PT 110** (0 - 1000 °C) allows **measurements of moulds, conveyor belts and glassware** before entering and after leaving the **lehr**; therefore it is an important tool for the plant operator.

The **CellaPort PT 140/143** is a portable two-colour pyrometer that supplies reliable measurement readings even in a very dusty and steamy environment or when gob diameters are very small. The CellaPort PT 143 has a rectangular measurement area. This greatly facilitates “looking” at the target object from a large distance.

Conclusion

- We have described the specificities of pyrometry temperature measurements for a transparent radiation source glass. We have also introduced both stationary and portable pyrometers to measure the temperature of glass in melting tanks, workcells and feeders and for the measurement of gobs, moulds and glass products.
- The selection of a single channel pyrometer is based on the condition “maximum measuring depth X99 of the pyrometer < glass thickness at the measuring site”.
- A two-colour pyrometer should fulfil the condition “1/6 of the maximum visibility depth X99 of the pyrometer < glass thickness at the measuring site < maximum measuring depth X99”.
- Unlike thermocouples, pyrometers are not subject to an ageing process and have a long service life.
- Pyrometers require a certain degree of maintenance to cool the optical system and to keep it clean.

Summary of stationary pyrometers and their technical specifications

Series	Type	Spectral range	Measuring range	Distance ratio ²⁾	Min. target size	Focal range	Sighting aid	
Stationary spectral pyrometers								
CellaTemp PA 10	AF 1	8 - 14 μm	0 - 1000 °C	50 : 1	\varnothing 6.00 mm	0.30 m - ∞	Through-the-lens sighting Video camera Laser-spot light	
	AF 2			48 : 1	\varnothing 3.13 mm	0.15 m - 0.30 m		
CellaTemp PA 15	AF 1	4.6 - 4.9 μm	500 - 2500 °C	70 : 1	\varnothing 11.43 mm	0.80 m - ∞		
	AF 2		300 - 1300 °C	45 : 1	\varnothing 17.78 mm	0.80 m - ∞		
CellaTemp PA 20	AF 1	1.1 - 1.7 μm	250 - 2000 °C	175 : 1	\varnothing 2.29 mm	0.40 m - ∞		
	AF 3			275 : 1	\varnothing 4.36 mm	1.20 m - ∞		
	AF 9			380 : 1	\varnothing 1.58 mm	0.60 m - ∞		
CellaTemp PA 30	AF 1	0.78 - 1.06 μm	500 - 2500 °C	210 : 1	\varnothing 1.90 mm	0.40 m - ∞		
	AF 3			310 : 1	\varnothing 3.87 mm	1.20 m - ∞		
	AF 5			430 : 1	\varnothing 1.40 mm	0.60 m - ∞		
CellaTemp PK 11	AF 1	8 - 14 μm	0 - 1000 °C	27 : 1	\varnothing 11.00 mm	0.30 m	-	
	AF 2			27 : 1	\varnothing 33.00 mm	0.90 m		
CellaTemp PK 21	AF 1	1.0 - 1.7 μm	250 - 1600 °C	150 : 1	\varnothing 10.00 mm	1.50 m		
CellaTemp PK 31	AF 1	0.78 - 1.06 μm	500 - 2500 °C	188 : 1	\varnothing 8.00 mm	1.50 m		
CellaTemp PK 41	AF 1	4.6 - 4.9 μm	300 - 1300 °C	36 : 1	\varnothing 11.00 mm	0.40 m		
CellaTemp PK 42	AF 1		500 - 2500 °C	57 : 1	\varnothing 7.00 mm	0.40 m		
Stationary two-colour pyrometers								
CellaTemp PA 40	AF 1	0.95 / 1.05 μm	650 - 1700 °C	80 : 1	\varnothing 5.00 mm	0.40 m - ∞		Through-the-lens sighting Video camera Laser-spot light
	AF 3			120 : 1	\varnothing 10.00 mm	1.20 m - ∞		
	AF 21			190 : 1	\varnothing 3.16 mm	0.60 m - ∞		
	AF 4		750 - 2400 °C	150 : 1	\varnothing 2.67 mm	0.40 m - ∞		
	AF 6			240 : 1	\varnothing 5.00 mm	1.20 m - ∞		
	AF 22			370 : 1	\varnothing 1.62 mm	0.60 m - ∞		
CellaTemp PK 68	AF 1	0.95 / 1.05 μm	550 - 1400 °C	71 : 1	\varnothing 21.00 mm	1.50 m	-	
Stationary spectral pyrometers with fibre optics cable								
CellaTemp PA 21	AF 11	1.1 - 1.7 μm	300 - 2000 °C	180 : 1	\varnothing 1.11 mm	0.20 m - ∞	Laser spot light	
	AF 21			100 : 1	\varnothing 1.20 mm	0.12 m - ∞		
	AF 901		450 - 2500 °C	320 : 1	\varnothing 1.56 mm	0.50 m - ∞		
CellaTemp PA 36	AF 11	0.82 - 0.93 μm	650 - 3000 °C	190 : 1	\varnothing 1.05 mm	0.20 m - ∞		
	AF 21			100 : 1	\varnothing 1.20 mm	0.12 m - ∞		
CellaTemp PKF 26	AF 1	1.0 - 1.7 μm	300 - 1600 °C	180 : 1	\varnothing 1.90 mm	0.20 m - ∞		External laser spot light
	AF 3			100 : 1	\varnothing 1.20 mm	0.12 m - ∞		
CellaTemp PKF 36	AF 1	0.78 - 1.06 μm	550 - 2500 °C	190 : 1	\varnothing 1.05 mm	0.20 m - ∞		
	AF 3			100 : 1	\varnothing 1.20 mm	0.12 m - ∞		
Stationary two-colour pyrometers with fibre optics cable								
CellaTemp PA 41	AF 11	0.95 / 1.05 μm	800 - 2400 °C	190 : 1	\varnothing 1.05 mm	0.20 m - ∞	Laser spot light	
	AF 21			100 : 1	\varnothing 1.20 mm	0.12 m - ∞		
	AF 111		900 - 3000 °C	190 : 1	\varnothing 1.05 mm	0.20 m - ∞		
	AF 121			100 : 1	\varnothing 1.20 mm	0.12 m - ∞		
	AF 211		700 - 1800 °C	110 : 1	\varnothing 1.82 mm	0.20 m - ∞		
	AF 221			50 : 1	\varnothing 2.40 mm	0.12 m - ∞		
CellaTemp PKF 66	AF 1			190 : 1	\varnothing 1.05 mm	0.20 m - ∞	External laser spot light	
Stationary infrared temperature switches								
CellaSwitch PKS 20	AF 1	1.0 - 1.7 μm	250 - 1250 °C	95 : 1	\varnothing 15.79 mm	1.50 m	-	
Stationary infrared temperature switches with fibre optics cable								
CellaSwitch PKS 21	AF 1	1.0 - 1.7 μm	350 - 1350 °C	120 : 1	\varnothing 12.50 mm	1.50 m	-	

Summary of stationary pyrometers and their technical specifications

Series	Type	Spectral range	Measuring range	Distance ratio ²⁾	Min. target size	Focal range	Sighting aid
Stationary two-colour pyrometers with rectangular measurement area (panorama pyrometer [®])							
CellaTemp PA 43	AF 1	0.95 / 1.05 μm	650 - 1700 °C	v = 230 : 1 h = 45 : 1	8.89 x 1.74 mm	0.40 m - ∞	Through-the-lens sighting Video camera Laser-spot light
	AF 3			v = 375 : 1 h = 75 : 1	16.00 x 3.20 mm	1.20 m - ∞	
	AF 21			v = 500 : 1 h = 95 : 1	6.32 x 1.20 mm	0.60 m - ∞	
	AF 4		750 - 2400 °C	v = 350 : 1 h = 50 : 1	8.00 x 1.14 mm	0.40 m - ∞	
	AF 6			v = 580 : 1 h = 85 : 1	14.12 x 2.07 mm	1.20 m - ∞	
	AF 17			v = 390 : 1 h = 97 : 1	0.89 x 0.22 mm	86 mm - 115 mm	
	AF 22			v = 730 : 1 h = 105 : 1	5.71 x 0.82 mm	0.60 m - ∞	
CellaTemp PKL 63	AF 1	650 - 1600 °C	v = 350 : 1 h = 51 : 1	4.10 x 0.60 mm	0.21 mm	External laser spot light	
	AF 2		v = 370 : 1 h = 54 : 1	18.50 x 2.70 mm	1.00 mm		

Summary of portable pyrometers and their technical specifications

Series	Type	Spectral range	Measuring range	Distance ratio ²⁾	Min. target size	Focal range	Sighting aid
Portable spectral pyrometers							
CellaPort PT 110	AF 1	8 - 14 μm	0 - 1000 °C	50 : 1	\varnothing 6.00 mm	0.30 m - ∞	Through-the-lens sighting
	AF 2			48 : 1	\varnothing 3.13 mm	0.15 m - 0.30 m	
CellaPort PT 115	AF 1	4.6 - 4.9 μm	500 - 2500 °C	70 : 1	\varnothing 11.43 mm	0.80 m - ∞	
	AF 2		300 - 1300 °C	45 : 1	\varnothing 17.78 mm	0.80 m - ∞	
CellaPort PT 120	AF 1	1.1 - 1.7 μm	250 - 2000 °C	175 : 1	\varnothing 2.29 mm	0.40 m - ∞	
	AF 3			275 : 1	\varnothing 4.36 mm	1.20 m - ∞	
CellaPort PT 130	AF 1	0.78 - 1.06 μm	500 - 2500 °C	210 : 1	\varnothing 1.90 mm	0.40 m - ∞	
	AF 3			310 : 1	\varnothing 3.87 mm	1.20 m - ∞	
Portable two-colour pyrometers							
CellaPort PT 140	AF 1	0.95 / 1.05 μm	650 - 1700 °C	80 : 1	\varnothing 5.00 mm	0.40 m - ∞	Through-the-lens sighting
	AF 3			120 : 1	\varnothing 10.00 mm	1.20 m - ∞	
	AF 4		750 - 2400 °C	150 : 1	\varnothing 2.67 mm	0.40 m - ∞	
	AF 6			240 : 1	\varnothing 5.00 mm	1.20 m - ∞	
Portable two-colour pyrometers with rectangular measurement area (panorama pyrometer [®])							
CellaPort PT 143	AF 1	0.95 / 1.05 μm	650 - 1700 °C	v = 230 : 1 h = 45 : 1	8.89 x 1.74 mm	0.40 m - ∞	Through-the-lens sighting
	AF 3			v = 375 : 1 h = 75 : 1	16.00 x 3.20 mm	1.20 m - ∞	
	AF 4		750 - 2400 °C	v = 350 : 1 h = 50 : 1	8.00 x 1.14 mm	0.40 m - ∞	
	AF 6			v = 580 : 1 h = 85 : 1	14.12 x 2.07 mm	1.20 m - ∞	

Delivery program



CellaTemp® PX

Pyrometers with IO-Link interface, focusable lens, through the lens sighting or laser spot light.



CellaTemp® PX-LWL

Pyrometers with IO-Link interface, fibre optics, focusable measuring heads and laser spot light.



CellaTemp PA Series

Versatile pyrometers with focusable lens, through-the-lens sighting/ laser spotlight or video camera.



CellaTemp PA-LWL

Versatile fiber optics pyrometers with focusable head and laser spotlight.



CellaTemp® PK(L) Series

Compact infrared thermometer for cramped environments. Optional with LED spot light.



CellaTemp® PKF

Compact infrared thermometer with optical fibre and optical sensor head.



CellaPort PT Series

Portable single-colour and two-colour pyrometers with through-the-lens sighting, laser spot light and USB interface.



Mikro PV

Intensity comparison pyrometer for ultra accurate measurement.

Since 1967, the Division Infrared Thermometer Solutions (ITS) of KELLER HCW GmbH develops and manufactures precision instruments and systems solutions for non-contact temperature measurements. Thanks to the continuous development of its range, KELLER ITS now is one of the leading providers for infrared thermometers and pyrometers worldwide.

With its very large product range of more than 250 models and systems KELLER ITS offers solutions for all standard applications and a variety of special measuring tasks.

Following the KELLER philosophy, the key focus in the development and production of the devices is set to the high measuring accuracy and reliability. Therefore, KELLER grants a warranty of 5 years on its products.

A global network of distributors and service points ensures competent and personal consultation on site.

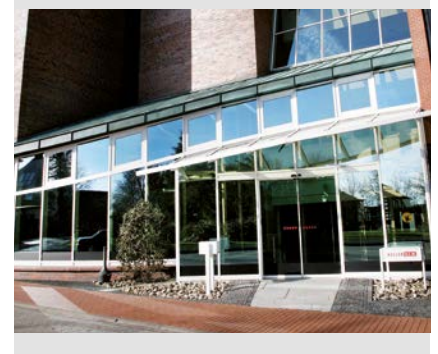

KELLER

Creating Solutions

infrared
temperature
solutions

ITS



- Headquarters
- Sales and Service Center
- Sales abroad



 **IO-Link**



Keller HCW GmbH
Infrared Temperature Solutions (ITS)
Carl-Keller-Straße 2-10
49479 Ibbenbüren-Laggenbeck
Germany

www.keller.de/its
Tel. +49 (0) 5451 850
Fax +49 (0) 5451 85412
its@keller.de

Sales and Service Center

Frankreich
www.keller.de/its
Tel. +33 (0) 951 453050
its@keller.de

Italien
www.giga-tech.it
Tel. +39 (0) 296489130
contatti@giga-tech.it

Österreich
www.sensotec.at
Tel. +43 313 551 650
office@sensotec.at

Russland
www.ampermetr.com
Tel. +7 343 384 55 45
info@ampermetr.com

Spanien
www.umi.es
Tel. +34 94 446 62 50
comercial@umi.es

China
www.keller-its.cn
Tel. +86 (0) 10 828 679-20
keller@germantech.com.cn

Indien
www.keller-itsindia.com
Tel. +91 (0) 98841 11025
info@keller-itsindia.com

Korea
www.ultratec.co.kr
Tel. +82 (0) 70 8282 5979
ellen@ultratec.co.kr