

Gewindeadapter PS 11/R AF1
 Thread adapter PS 11/R AF1
 nr./no. 561552

Montagebeispiel
 Mounting example

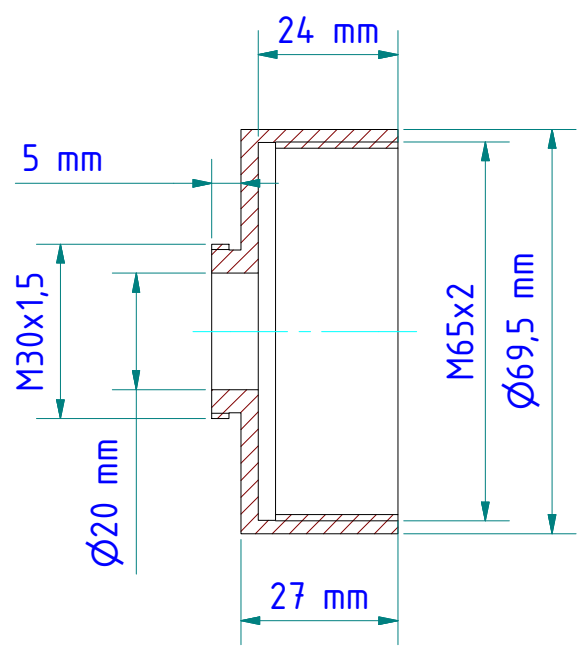

Gewicht: 0.078 Kg
 Weight: 0.078 Kg
 Werkstoff: 3.2315
 Material: 3.2315