

<i>Belegung</i> <i>Configuration</i>	<i>Pol</i> <i>contacts</i>
---	-------------------------------

braun <i>brown</i>	an 1 <i>at 1</i>
weiß <i>white</i>	an 2 <i>at 2</i>
blau <i>blue</i>	an 3 <i>at 3</i>
schwarz <i>black</i>	an 4 <i>at 4</i>
grau <i>grey</i>	an 5 <i>at 5</i>
Schirm durchgängig an Verschraubung <i>Shield constantly at screw connection</i>	

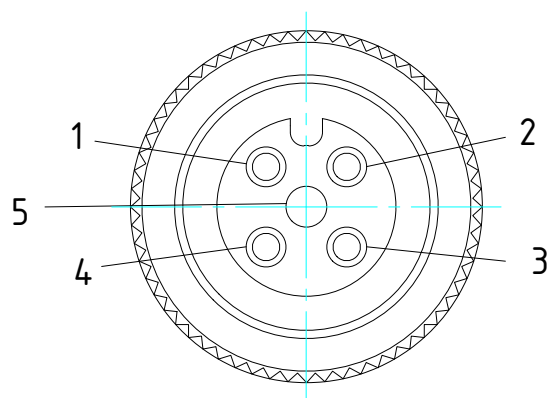

(Maßstab 3:1)

PUR-Kabel / *PUR cable*

Umgebungstemperatur [°C] / *Ambient temperature* -25...90, cULus: max. 75 °C

Schutzart / *Protection* IP 65 / IP 67

Gewicht: 0.220 Kg

Weight: 0.220 Kg

Seite 1 von 1

Page 1 of 1

KELLER

www.keller.de/its

Kabel
Cable

VK 02/L AF1

Artikel-Nr.: 1043813

Ersteller: Neukötter 16.05.2018 Z-Index: 04