

Montagebeispiel
Mounting example

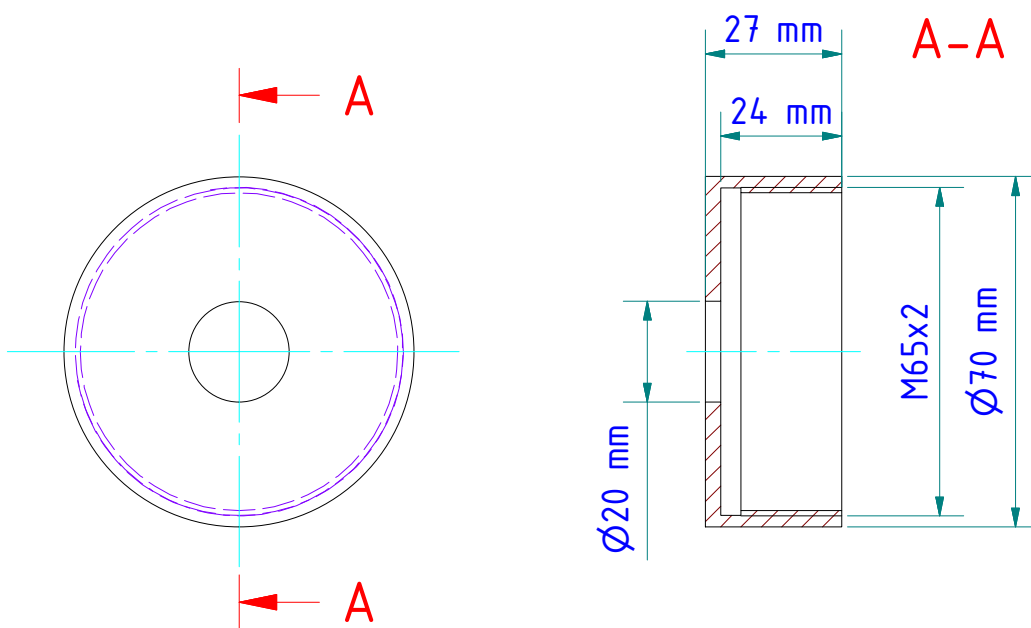

Gewicht: 0.066 Kg
 Weight: 0.066 Kg
 Werkstoff: 3.2315
 Material: 3.2315