

Stückliste / Parts list

Pos.	Artikel-Nr.: <i>order number</i>	Bezeichnung <i>title</i>
1	1024087	Pyrometer CellaTemp PA 20 AF 3/L <i>Pyrometer CellaTemp PA 20 AF 3/L</i>
2	1080943	Montagekombination PA 83-010 <i>Mounting PA 83-010</i>

Gewicht: 9.380 Kg
Weight: 9.380 Kg

Seite 1 von 1
Page 1 of 1



Kabel VK 02/A AFx
Cable VK 02/A AFx

Optik	min. [mm]	max. [mm]
Standard Optik PZ 10.01 <i>Standard lens PZ 10.01</i>	35,0	44,4
Nah Optik PZ 10.05 <i>close-up lens PZ 10.05</i>	35,0	44,4
Standard Optik PZ 15.03 <i>Standard lens PZ 15.03</i>	51,5	65,0
Standard Optik PZ 20.01 <i>Standard lens PZ 20.01</i>	49,8	69,9
Nah Optik PZ 20.03 <i>Close-up lens</i>	49,7	67,9
Panorama Optik PZ 40.03 <i>Panorama Optik PZ 40.03</i>	52,1	67,9
Weitwinkel Optik PZ 20.05 <i>Wide-angle lens PZ 20.05</i>	62,8	64,7
Tele Optik PZ 20.06 <i>Telephoto lens PZ 20.06</i>	93,0	112,0
Spezial Optik PZ 20.08 <i>Special lens PZ 20.08</i>	35,0	44,4

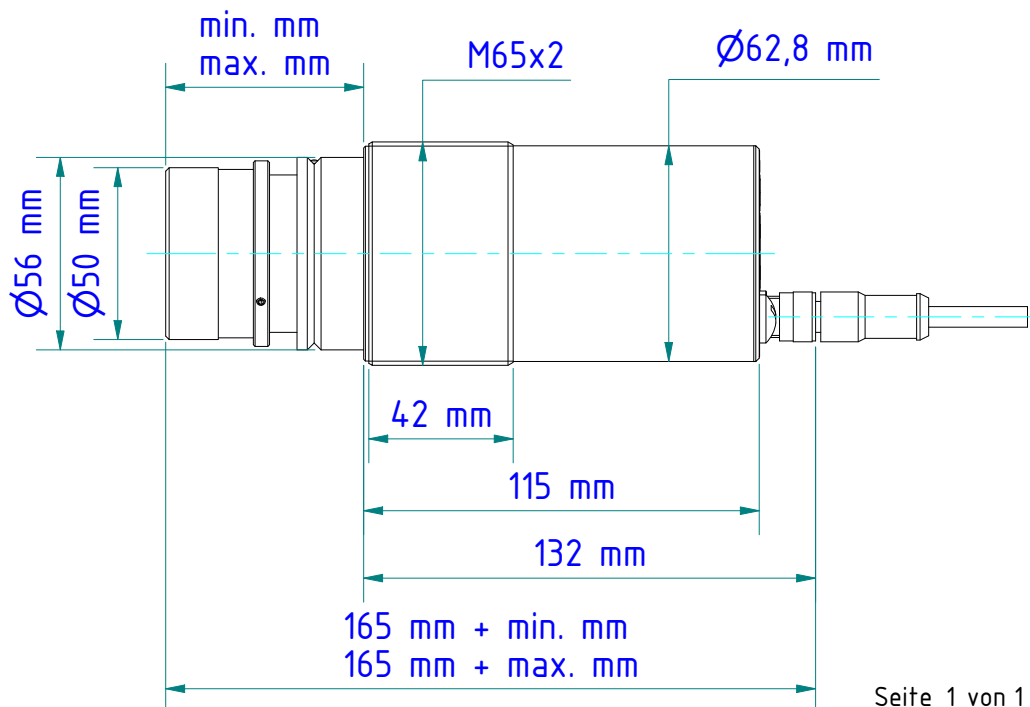

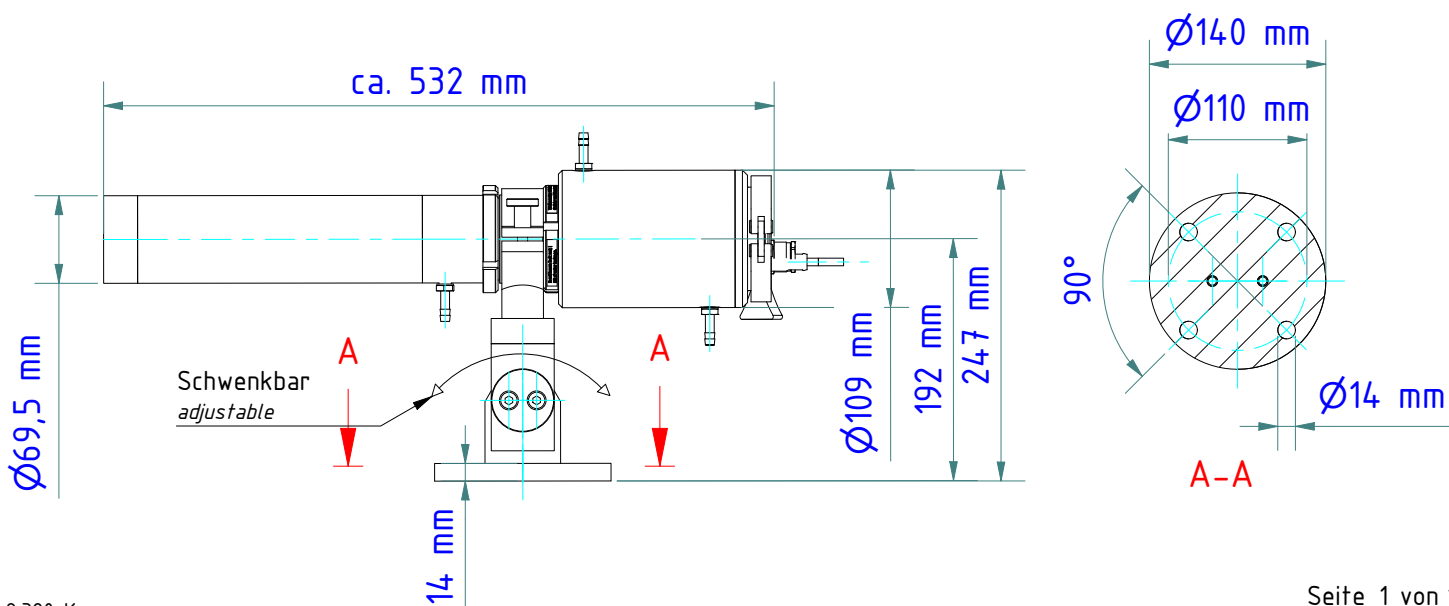
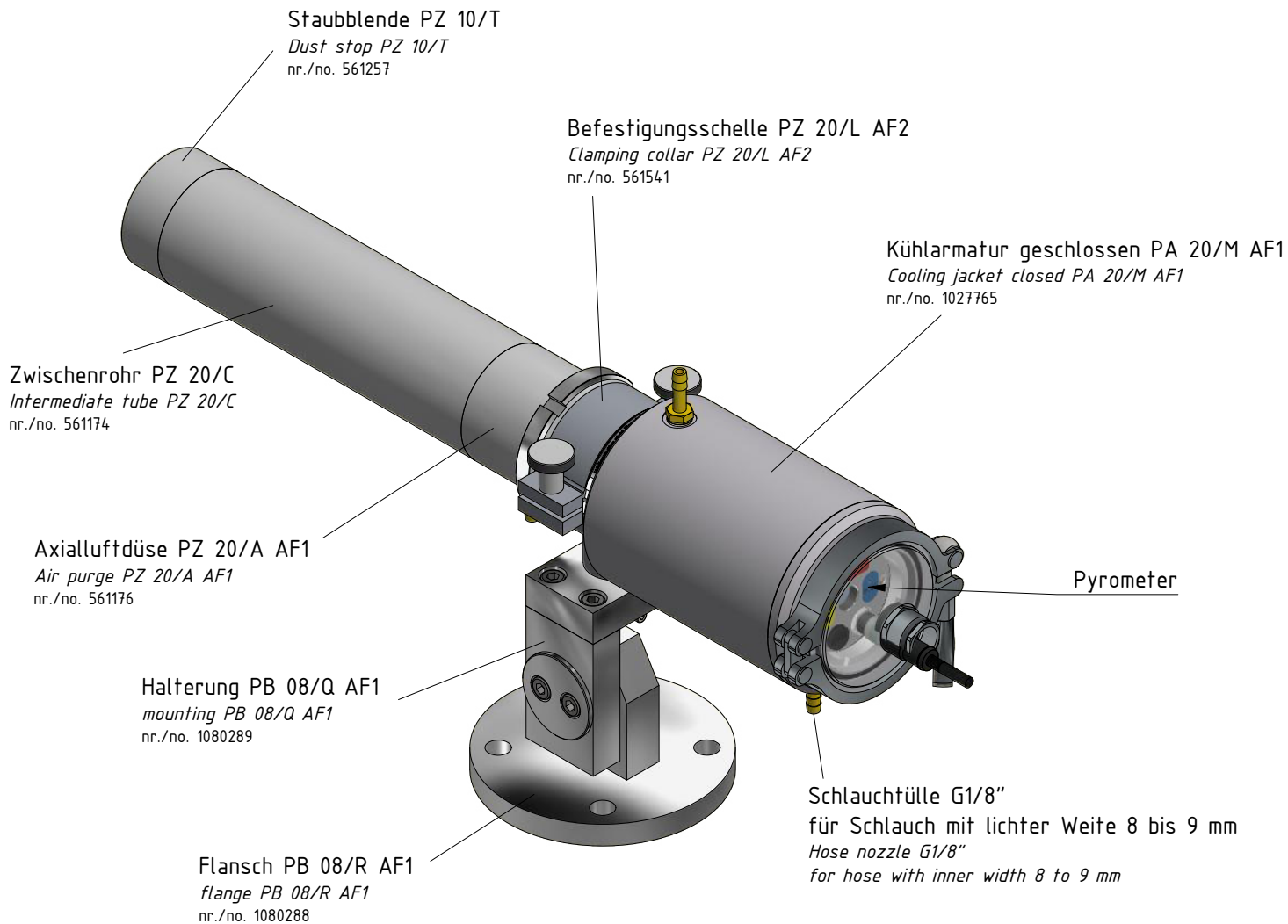

Gewicht: 8.320 Kg
Weight: 8.320 Kg

Seite 1 von 1
Page 1 of 1